



**INTERCONNECTION
FACILITIES STUDY
REPORT**

GEN-2017-150

Published April 2023

By SPP Generator Interconnections Dept.

REVISION HISTORY

DATE OR VERSION NUMBER	AUTHOR	CHANGE DESCRIPTION
04/12/2023	SPP	Initial draft report issued.
05/02/2023	SPP	Updated upgrade information and cost for UIDs 156445 & 156471 in Table 3.
06/06/2023	SPP	Updated 156496, 156497 and 156493 allocation costs.
07/05/2023	SPP	Cost revisions made for UIDs 156858 in Table 3.

CONTENTS

Revision History	i
Summary	1
Introduction	1
Phase(s) of Interconnection Service	1
Compensation for Amounts Advanced for Network Upgrade(s).....	1
Interconnection Customer Interconnection Facilities	2
Transmission Owner Interconnection Facilities and Non-Shared Network Upgrade(s).....	3
Shared Network Upgrade(s)	4
Contingent Network Upgrade(s).....	6
Affected System Upgrade(s)	6
Conclusion.....	7
Appendices	8
A: Transmission Owner’s Interconnection Facilities Study Report and Network Upgrades Report(s).....	1

SUMMARY

INTRODUCTION

This Interconnection Facilities Study (IFS) for Interconnection Request is for a 250 MW generating facility located in Grady County, OK. The Interconnection Request was studied in the DISIS-2017-002 Impact Study for ERIS. The Interconnection Customer's requested in-service date is 12/01/2025.

The interconnecting Transmission Owner, Oklahoma Gas & Electric Company (OGE), performed a detailed IFS at the request of SPP. The full report is included in Appendix A. SPP determined that full Interconnection Service will be available after the assigned Transmission Owner Interconnection Facilities (TOIF), Non-Shared Network Upgrades, Shared Network Upgrades, Contingent Network Upgrades, and Affected System Upgrades that are required for full interconnection service are completed.

The primary objective of the IFS is to identify necessary Transmission Owner Interconnection Facilities, Network Upgrades, other direct assigned upgrades, cost estimates, and associated upgrade lead times needed to grant the requested Interconnection Service.

PHASE(S) OF INTERCONNECTION SERVICE

It is not expected that Interconnection Service will occur in phases. However, full Interconnection Service will not be available until all Interconnection Facilities and Network Upgrade(s) can be placed in service.

COMPENSATION FOR AMOUNTS ADVANCED FOR NETWORK UPGRADE(S)

FERC Order ER20-1687-000 eliminated the use of Attachment Z2 revenue crediting as an option for compensation. The Incremental Long Term Congestion Right (ILTCR) process will be the sole process to compensate upgrade sponsors as of July 1st, 2020.

INTERCONNECTION CUSTOMER INTERCONNECTION FACILITIES

The Generating Facility is proposed to consist of one-hundred thirty eight (138) 1.8 MW inverters and one (1) 1.6 MW inverter for a total generating nameplate capacity of 250 MW.

The Interconnection Customer's Interconnection Facilities to be designed, procured, constructed, installed, maintained, and owned by the Interconnection Customer at its sole expense include:

34.5 kV underground cable collection circuits;

34.5 kV to 345 kV transformation substation with associated 34.5 kV and 345 kV switchgear;

One 345/34.5 kV 168/224/280 MVA (ONAN/ONAF/ONAF) step-up transformer to be owned and maintained by the Interconnection Customer at the Interconnection Customer's substation;

31 miles kV line to connect the Interconnection Customer's substation to the Point of Interconnection ("POI") at the 345 kV bus at existing Transmission Owner substation ("Minco 345kV") that is owned and maintained by Transmission Owner;

All transmission facilities required to connect the Interconnection Customer's substation to the POI;

Equipment at the Interconnection Customer's substation necessary to maintain a composite power delivery at continuous rated power output at the high-side of the generator substation at a power factor within the range of 95% lagging and 95% leading in accordance with Federal Energy Regulatory Commission (FERC) Order 827. The Interconnection Customer may use inverter manufacturing options for providing reactive power under no/reduced generation conditions. The Interconnection Customer will be required to provide documentation and design specifications demonstrating how the requirements are met; and,

All necessary relay, protection, control and communication systems required to protect Interconnection Customer's Interconnection Facilities and Generating Facilities and coordinate with Transmission Owner's relay, protection, control and communication systems.

TRANSMISSION OWNER INTERCONNECTION FACILITIES AND NON-SHARED NETWORK UPGRADE(S)

To facilitate interconnection, the interconnecting Transmission Owner will perform work as shown below necessary for the acceptance of the Interconnection Customer’s Interconnection Facilities.

Table 1 and **Table 2** lists the Interconnection Customer’s estimated cost responsibility for Transmission Owner Interconnection Facilities (TOIF) and Non-Shared Network Upgrade(s) and provides an estimated lead time for completion of construction. The estimated lead time begins when the Generator Interconnection Agreement has been fully executed.

Table 1: Transmission Owner Interconnection Facilities (TOIF)

Transmission Owner Interconnection Facilities (TOIF)	Total Cost Estimate (\$)	Allocated Percent (%)	Allocated Cost Estimate (\$)	Estimated Lead Time
<u>Minco 345kV GEN-2017-150 Interconnection (TOIF) (OGE) (143403)</u> Interconnection upgrades and cost estimates needed to interconnect the following Interconnection Customer facility, GEN-2017-150 (250 MW/Solar), into the Point of Interconnection (POI) at Minco 345kV	\$795,827	100%	\$795,827	20 Months
Total	\$795,827		\$795,827	

Table 2: Non-Shared Network Upgrade(s)

Non-Shared Network Upgrades Description	ILTCR	Total Cost Estimate (\$)	Allocated Percent (%)	Allocated Cost Estimate (\$)	Estimated Lead Time
<u>NA</u>	NA	NA	NA	NA	NA
Total		NA		NA	

SHARED NETWORK UPGRADE(S)

The Interconnection Customer’s share of costs for Shared Network Upgrades is estimated in **Table 3** below.

Table 3: Interconnection Customer Shared Network Upgrade(s)

Shared Network Upgrades Description	ILTCR	Total Cost Estimate (\$)	Allocated Percent (%)	Allocated Cost Estimate (\$)	Estimated Lead Time
<u>Minco 345kV Interconnection Expansion (DISIS-2017-002)(143402)(OGE):</u> Expand the Minco 345kV substation to accommodate the interconnection of GEN-2017-150 and GEN-2017-233	Ineligible	\$1,790,448.00	53.76%	\$962,606.45	20 Months
<u>Reactive Support at Randall 230Kv (156857)(SPS):</u> Install three (3) 28.8 MVAR capacitor banks, one (1) 14.4 MVAR capacitor bank, and a 100 MVAR STATCOM at Randall 230 kV	Eligible	\$66,361,449.00	11.40%	\$2,796,145.14	36 Months
<u>Reactive Support at Sweetwater 230kV (156858)(AEP):</u> Install a total of 64 MVAR of capacitor banks and a 106 MVar STATCOM at Sweetwater 230 kV	Eligible	\$58,762,790	11.40%	\$6,696,210.11	36 Months
<u>Renfrow 345 kV Terminal Equipment Upgrade (DISIS-2017-002) (OGE)(156445):</u> Upgrade terminal equipment at point of change (OK/KS State Line) to accept Viola 345 kV line rebuild to achieve minimum summer/emergency rating of 1195 MVA.	Eligible	\$250,000	4.83%	\$12,066.64	36 Months
<u>Switch Out Border Line Reactor (DISIS-2017-002)(156496)(OGE):</u> Switch out the Border 345 kV (50 MVAR) - Tuco line reactors to be switchable	Eligible	\$1,790,448.00	11.40%	\$204,027.34	20 Months
<u>Switch Out Carpenter Line Reactor (DISIS-2017-002)(156493)(SPS):</u> Switch	Eligible	\$836,245.00	11.40%	\$95,292.82	36 Months

<u>out the Carpenter 25 MVAR line reactor on the Carpenter to Hitchland 345 kV line to be remote switchable.</u>					
<u>Switch Out Finney and Carpenter Line Reactors (DISIS-2017-002)(156495)(SPS):</u> Switch out the Finney 345 kV (50 MVAR) - Carpenter 345 kV (25 MVAR) 345kV line reactors to be switchable	Eligible	\$1,884,762.00	11.40%	\$129,105.60	1 Month
<u>Switch Out Potter County Line Reactor (DISIS-2017-002)(156494)(SPS):</u> Switch out the Potter County 345 kV 75 MVAR line reactor on the Potter County to Hitchland 345 kV line to be remote switchable	Eligible	\$1,228,089.00	11.40%	\$64,552.80	36 Months
<u>Switch Out Tuco Line Reactor (DISIS-2017-002)(156497)(SPS):</u> Switch out the Border 345 kV (50 MVAR) - Tuco 345 kV (100 MVAR) 345kV line reactors to be switchable	Eligible	\$2,316,446.00	11.40%	\$263,966.52	36 Months
<u>Viola to Renfrow 345 kV Rebuild (WERE) (DISIS-2017-002) (156471):</u> Rebuild the existing Viola to Renfrow 345 kV line from Viola to the OK/KS State Line (23 miles) to achieve a minimum summer/emergency rating of 1195 MVA	Eligible	\$47,418,633.00	4.83%	\$2,288,735.01	36 Months
Total		\$182,639,310		\$13,512,708.43	

All studies have been conducted assuming that higher-queued Interconnection Request(s) and the associated Network Upgrade(s) will be placed into service. If higher-queued Interconnection Request(s) withdraw from the queue, suspend or terminate service, the Interconnection Customer's share of costs may be revised. Restudies, conducted at the customer's expense, will determine the Interconnection Customer's revised allocation of Shared Network Upgrades.

CONTINGENT NETWORK UPGRADE(S)

Certain Contingent Network Upgrades are **currently not the cost responsibility** of the Interconnection Customer but will be required for full Interconnection Service.

Table 4: Interconnection Customer Contingent Network Upgrade(s)

Contingent Network Upgrade(s) Description	Current Cost Assignment	Estimated In-Service Date
<u>NTC 210627- Multi - Border - Woodward 345 kV Tap:</u> Build 0.84-miles of new 345 kV line from a new tap on the Woodward to Border 345 kV line to Chisholm	\$2,831,198.18	TBD

Depending upon the status of higher- or equally-queued customers, the Interconnection Request’s in-service date is at risk of being delayed or Interconnection Service is at risk of being reduced until the in-service date of these Contingent Network Upgrades.

AFFECTED SYSTEM UPGRADE(S)

To facilitate interconnection, the Affected System Transmission Owner will be required to perform the facilities study work as shown below necessary for the acceptance of the Interconnection Customer’s Interconnection Facilities. **Table 5** displays the current impact study costs provided by either MISO or AECI as part of the Affected System Impact review. The Affected System facilities study could provide revised costs and will provide each Interconnection Customer’s allocation responsibilities for the upgrades.

Table 5: Interconnection Customer Affected System Upgrade(s)

Affected System Upgrades Description	Total Cost Estimate (\$)	Allocated Percent (%)	Allocated Cost Estimate (\$)
<u>NA</u>	NA	NA	NA
Total	NA		NA

CONCLUSION

After all Interconnection Facilities and Network Upgrades have been placed into service, Interconnection Service for MW can be granted. Full Interconnection Service will be delayed until the TOIF, Non-Shared NU, Shared NU, Contingent NU, Affected System Upgrades that are required for full interconnection service are completed. The Interconnection Customer’s estimated cost responsibility for full interconnection service is summarized in the table below.

Table 6: Cost Summary

Description	Allocated Cost Estimate
Transmission Owner Interconnection Facilities Upgrade(s)	\$795,827
Non-Shared Network Upgrade(s)	\$0
Shared Network Upgrade(s)	\$13,512,708.43
Affected System Upgrade(s)	\$0
Total	\$14,308,535.43

Use the following link for Quarterly Updates on upgrades from this report: <https://spp.org/spp-documents-filings/?id=18641>

A draft Generator Interconnection Agreement will be provided to the Interconnection Customer consistent with the final results of this IFS report. The Transmission Owner and Interconnection Customer will have 60 days to negotiate the terms of the GIA consistent with the SPP Open Access Transmission Tariff (OATT).

APPENDICES

**A: TRANSMISSION OWNER'S INTERCONNECTION FACILITIES STUDY REPORT
AND NETWORK UPGRADES REPORT(S)**

See next page for the Transmission Owner's Interconnection Facilities Study Report and Network Upgrades Report(s).



AEP Generation Interconnection

Facilities Study Report

for

DISIS 2017-002

Reactive support at Sweetwater 230 kV station

Beckham County, Texas

March 2023

Facilities Study Summary

American Electric Power (AEP) Southwest Transmission Planning performed the following study at the request of the Southwest Power Pool (SPP) for SPP Generation Interconnection request DISIS-2017-002. Per the SPP Generator Interconnection Procedures (GIP), SPP requested that AEP perform an Interconnection Facilities Study (IFS) for Network Upgrade(s) in accordance with Attachment V, Section 8.11 of the Generator Interconnection Procedures (GIP).

Sweetwater 230kV

Install 170 MVAR of reactive support that will include an approximately 106 MVAR Statcom and a 64 MVAR capacitor bank and associated equipment

Project Description

Per the DISIS-2017-002 study request, AEP proposes to Install 170 MVAR of reactive support that will include an approximately 106 MVAR Statcom and a 64 MVAR capacitor bank and associated bus work and equipment at the AEP Sweetwater station(Figure 1) in Beckham County, Oklahoma (Figure 2).

AEP's Scope of Work to Facilitate Interconnection

To accommodate the reactive support request at the Sweetwater 230 kV station, The existing configuration and footprint will need to be expanded. The design and construction of the new bus work will meet all AEP specifications. Bus work and disconnect switches will be designed to accommodate the loading requirements, and circuit breakers will be rated to ensure adequate load and fault interrupting capability. AEP will own, operate and maintain the 230 kV Sweetwater station. Installation of associated protection and control equipment, and SCADA required at the Sweetwater 230 kV station. AEP reserves the right to specify the final acceptable configuration considering design practices, future expansion, and compliance requirements.

It is understood that the Interconnection Customers are responsible for the cost of all of this work.

Short Circuit Evaluation

It is standard practice for AEP to recommend replacing a circuit breaker when the current through the breaker for a fault exceeds 100% of its interrupting rating with recloser de-rating applied, as determined by the ANSI/IEEE C37.5-1979, C37.010-1979 & C37.04-1979 breaker rating methods. In the AEP system, no breakers were found to exceed their interrupting capability after the addition of this equipment. Therefore, there are no additional short circuit upgrade costs associated with the DISIS-2017-002, UID 156858 interconnection.

Interconnection Cost of Facilities Included in the Facilities Study:

Install 106 MVAR Statcom and 64 MVAR capacitor bank at 230 kV Sweetwater station	\$58,762,790
Total Cost	\$58,762,790

The estimates do not include the impact that delays in obtaining ROW, permits, or other approvals may have.

Project Lead time

Project in-service date is projected to be 36-42 months after the issuance of Authorization to Proceed from the Interconnection Customer. This is primarily due to the current timeline for scoping, bidding, and acquiring the STATCOM unit.

Figure 1: Point of Interconnection (POI INFORMATION) One-Line Diagram

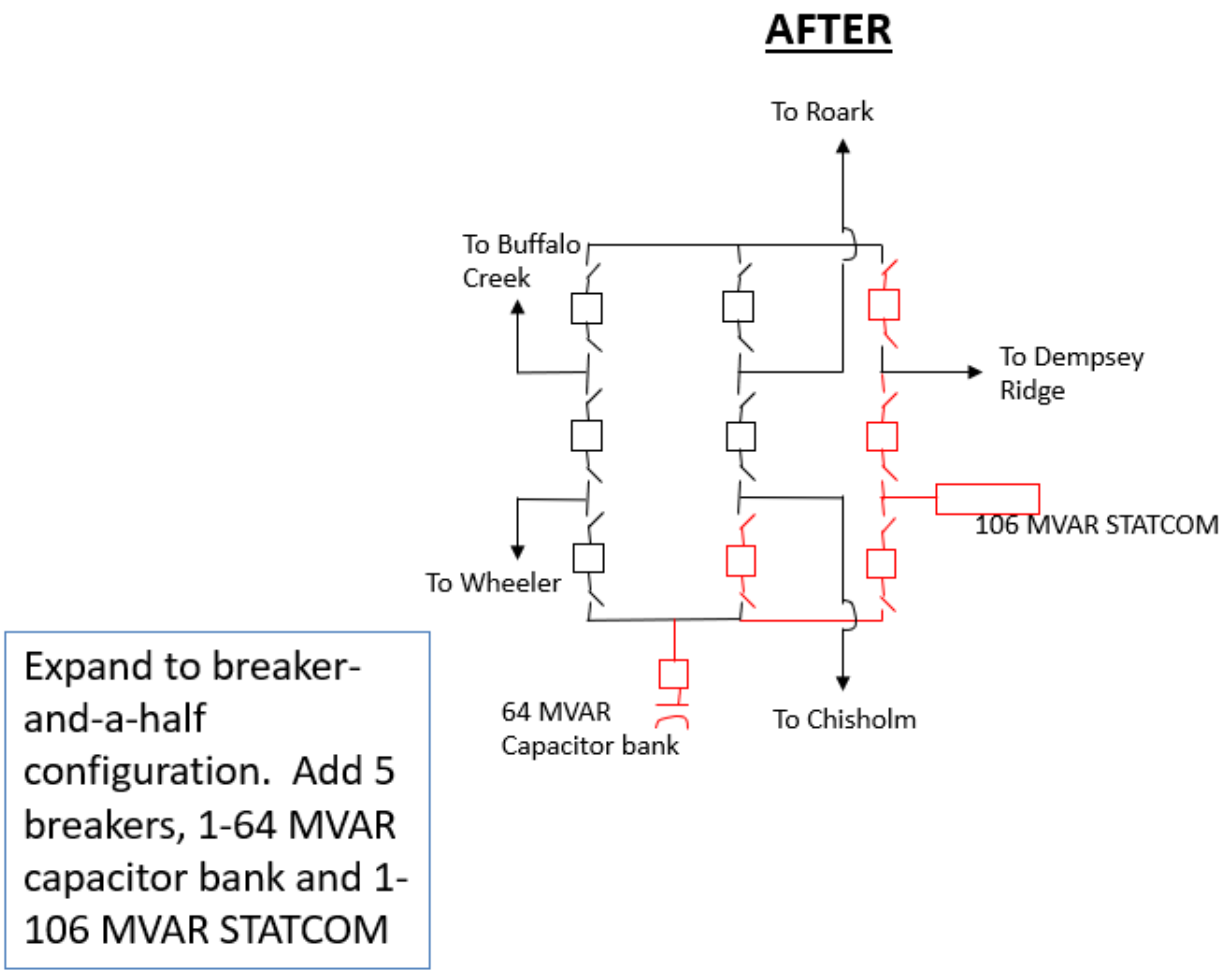
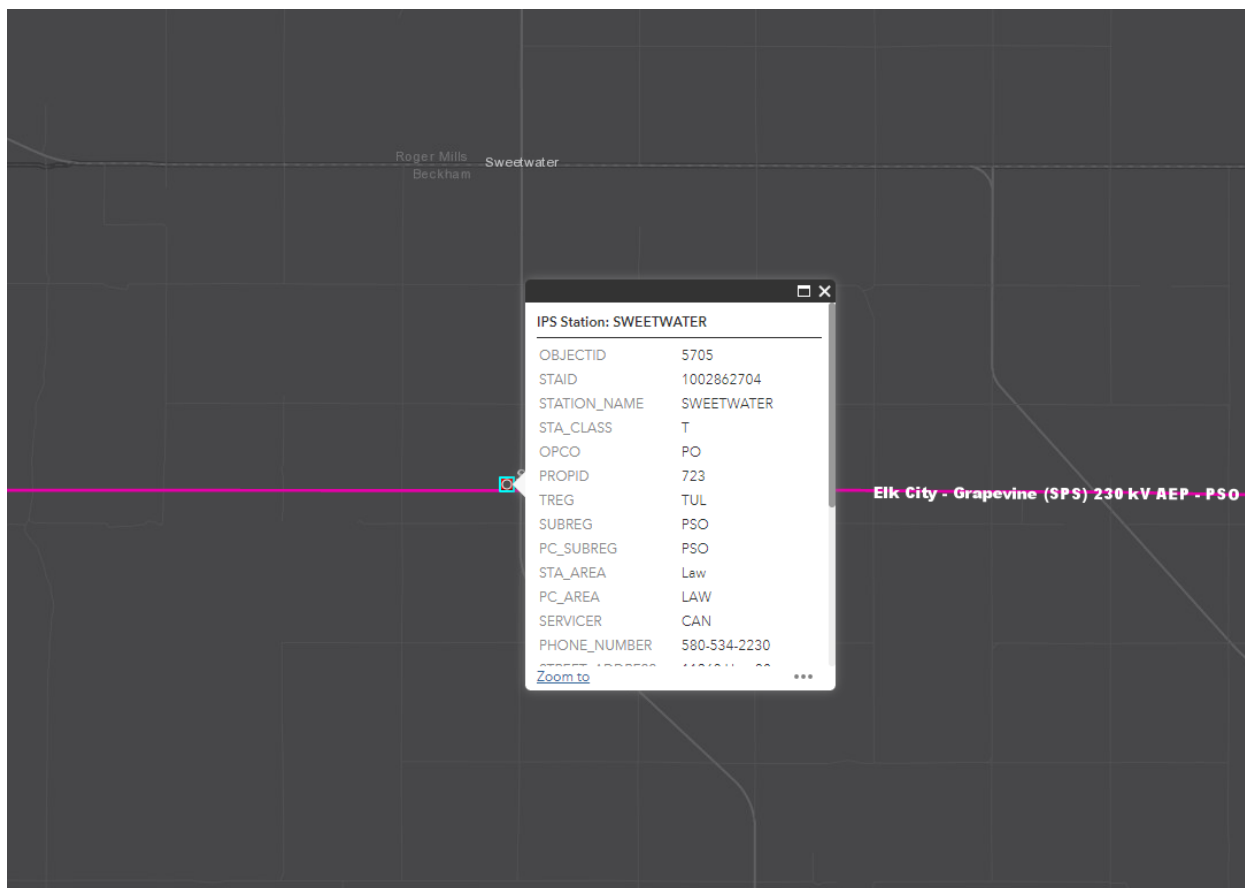

Figure 2: Point of Interconnection Map





Interconnection Facilities Study

Network Upgrades associated with DISIS-2017-002 Rev. 3

June 2023

Introduction

This report summarizes the scope of the Interconnection Facilities Analysis for Network Upgrade(s) to determine costs related to the addition of the SPP-GI DISIS-2017-002 Interconnection Request(s).

Southwest Power Pool Generation Interconnection Request:

Per the SPP Generator Interconnection Procedures (GIP), SPP has requested that Evergy perform an Interconnection Facilities Study (IFS) for Network Upgrade(s) in accordance with the Scope of Interconnection Facilities Study GIP Section 8.10 and the Interconnection Facilities Study Procedures in accordance with GIP Section 8.11 for the following Interconnection Request(s):

Upgrade Type	UID	Upgrade Name	DISIS Cost	DISIS Lead Time
Interconnection	143452	Nashua – St. Joe 345kV New Interconnection Substation (Non-Shared NU) (DISIS-2017-002)	\$27,890,401	36 Months
Interconnection	143453	Nashua - St. Joe 345kV GEN - 2017-183 Interconnection (TOIF) (KCPL)	\$1,229,421	36 Months
Interconnection	143364	Abilene Energy Center – Northview 115kV GEN-2017-120 Interconnection (NU) (WERE)	\$10,641,983	36 Months
Interconnection	143500	LaCygne – Neosho 345kV GEN 2017-209 Interconnection (Non-Shared NU) (WERE)	\$30,439,276	36 Months
Interconnection	143501	LaCygne – Neosho 345kV GEN 2017-209 Interconnection (Non-Shared TOIF) (WERE)	\$1,705,966	36 Months
Network Upgrade	156516	Archie 161 kV Terminal Upgrades (DISIS-2017-002) (EMW)	\$1,455,934	36 Months
Network Upgrade	156851	Archie – G17-108 Tap 161 kV Rebuild (DISIS-2017-002) (EMW)	\$41,157,960	36 Months
Interconnection	143342	Stilwell – Clinton 161kV New Three (3) Breaker Ring Bus Interconnection Substation (DISIS-2017-002)	\$11,780,129	36 Months
Network Upgrade	156461	Craig to Lenexa 161 kV Double CKT 1 & 2 Rebuild (DISIS-2017-002)	\$8,294,859	36 Months
Network Upgrade	156457	Post Oak 69-35 kV Transformer Replacement (DISIS-2017-002) (EKC)	\$2,796,764	36 Months
Interconnection	143446	Gordon Evans 138kV Interconnection Expansion (DISIS-2017-002)	\$2,422,517	36 Months

Interconnection	143330	Post Oak 34.5kV ASGI-2017- 014 Interconnection (Non-Shared NU) (KCPL)	\$2,796,764	36 Months
Interconnection	143331	Post Oak 34.5kV ASGI-2017- 014 Interconnection (Non-Shared TOIF) (KCPL)	\$252,256	36 Months
Interconnection	143518	Buffalo Flats 345kV Interconnection Expansion (NU) (DISIS-2017 -002)	\$2,287,129	36 Months
Interconnection	143476	West Gardner 345kV Interconnection Expansion (NU) (DISIS-2017-002)	\$2,156,278	36 Months
Interconnection	143455	Nashua -St. Joe 345kV GEN - 2017-184 Interconnection (NU) (KCPL)	\$1,229,421	36 Months
Interconnection	143519	Buffalo Flats 345kV GEN-2017-220 Interconnection (TOIF) (WERE)	\$579,336	36 Months
Interconnection	143521	Buffalo Flats 345kV GEN-2017-221 Interconnection (TOIF) (WERE)	\$579,336	36 Months
Interconnection	143477	West Gardner 345kV GEN-2017-195 Interconnection (TOIF) (KCPL)	\$947,036	36 Months
Interconnection	143479	West Gardner 345kV GEN-2017-196 Interconnection (TOIF) (KCPL)	\$947,036	36 Months
Interconnection	143370	Swissvale 345kV GEN-2017-125 Interconnection Expansion (DISIS-2017-002)	\$25,565,648	36 Months
Interconnection	143371	Swissvale 345kV GEN-2017-125 Interconnection (TOIF) (WERE)	\$1,278,950	36 Months
Interconnection	143373	Swissvale 345kV GEN-2017-128 Interconnection (TOIF) (WERE)	\$1,278,950	36 Months
Interconnection	143365	Abilene Energy Center - Northview 115kV GEN-2017-120 Interconnection (TOIF) (WERE)	\$842,713	36 Months
Interconnection	143447	Gordon Evans 138kV GEN-2017-179 Interconnection (TOIF) (WERE)	\$717,053	36 Months
Interconnection	143534	Stilwell 345kV GEN-2017-229 Interconnection (NU) (KCPL)	\$78,073,008	36 Months
Interconnection	143535	Stilwell 345kV GEN-2017-229 Interconnection (TOIF) (KCPL)	\$1,341,356	36 Months
Interconnection	143354	Holt County 345kV GEN-2017-115 (NU) (KCPL)	\$1,016,595	36 Months
Interconnection	143355	Holt County 345kV GEN-2017-115 Interconnection (Non-Shared TOIF) (KCPL)	\$646,577	36 Months
Interconnection	143469	Swissvale 345kV GEN-2017-191 Interconnection (TOIF) (WERE)	\$639,474	36 Months
Interconnection	143471	Swissvale 345kV GEN-2017-192 Interconnection (TOIF) (WERE)	\$639,474	36 Months

Interconnection	143347	Clinton - Stilwell 161kV GEN-2017-111 Interconnection (TOIF) (KCPL)	\$1,262,482	36 Months
Interconnection	143343	Stillwell - Clinton 161kV GEN-2017-108 Interconnection (TOIF) (KCPL)	\$631,241	36 Months
Interconnection	143366	Sumner 138kV GEN-2017-121 Interconnection (Non-Shared NU) (WERE)	\$591,566	36 Months
Interconnection	143367	Sumner 138kV GEN-2017-121 Interconnection (TOIF) (WERE)	\$648,517	36 Months
Interconnection	143529	Gordon Evans 138kV GEN-2017-226 Interconnection (TOIF) (WERE)	\$372,381	36 Months
Interconnection	143531	Gordon Evans 138kV GEN-2017-227 Interconnection (TOIF) (WERE)	\$372,380	36 Months
Interconnection	143374	Altoona - NE Parson 138kV GEN-2017-131 Interconnection (Non-Shared NU) (WERE)	\$12,381	36 Months
Interconnection	143375	Altoona - NE Parson 138kV GEN-2017-131 Interconnection (TOIF) (WERE)	\$24,762	36 Months
Network Upgrade	156471	Viola to G17-185 Tap 345 kV Line Rebuild (DISIS-2017-002) (EKC)	\$47,418,635	36 Months

Nashua – St. Joe 345kV New Interconnection Substation (Non-Shared NU)

345 kV Substation

Construct the network upgrades required for the Horse Thief I wind farm GEN-201-183 generator interconnection. The interconnection sub be shared among GEN-2017-183 and GEN-2017-184. UID 143452

Total Cost

The total cost estimate for this Interconnection is:

\$	6,253,553	345kV Transmission Line
\$	21,356,767	345kV Substation
\$	280,080	AFUDC
\$	0	Contingency
<hr/>		
\$	27,890,401	Total

This estimate is accurate to +/- twenty (20) percent, based on current prices, in accordance with Attachment A of Appendix 4 of the Interconnection Facilities Study Agreement. However, recent cost fluctuations in materials are very significant and the accuracy of this estimate at the time of actual settings cannot be assured.

Time Estimate

Time estimates are based on current version of the project schedule and some processes of each category run concurrently.

Engineering Time	12-18	Months
Procurement Time	12-18	Months
Construction Time	12	Months
<hr/>		
Total Project Length	36-48	Months

Figure 1 – Nashua – St. Joseph 345kV Line

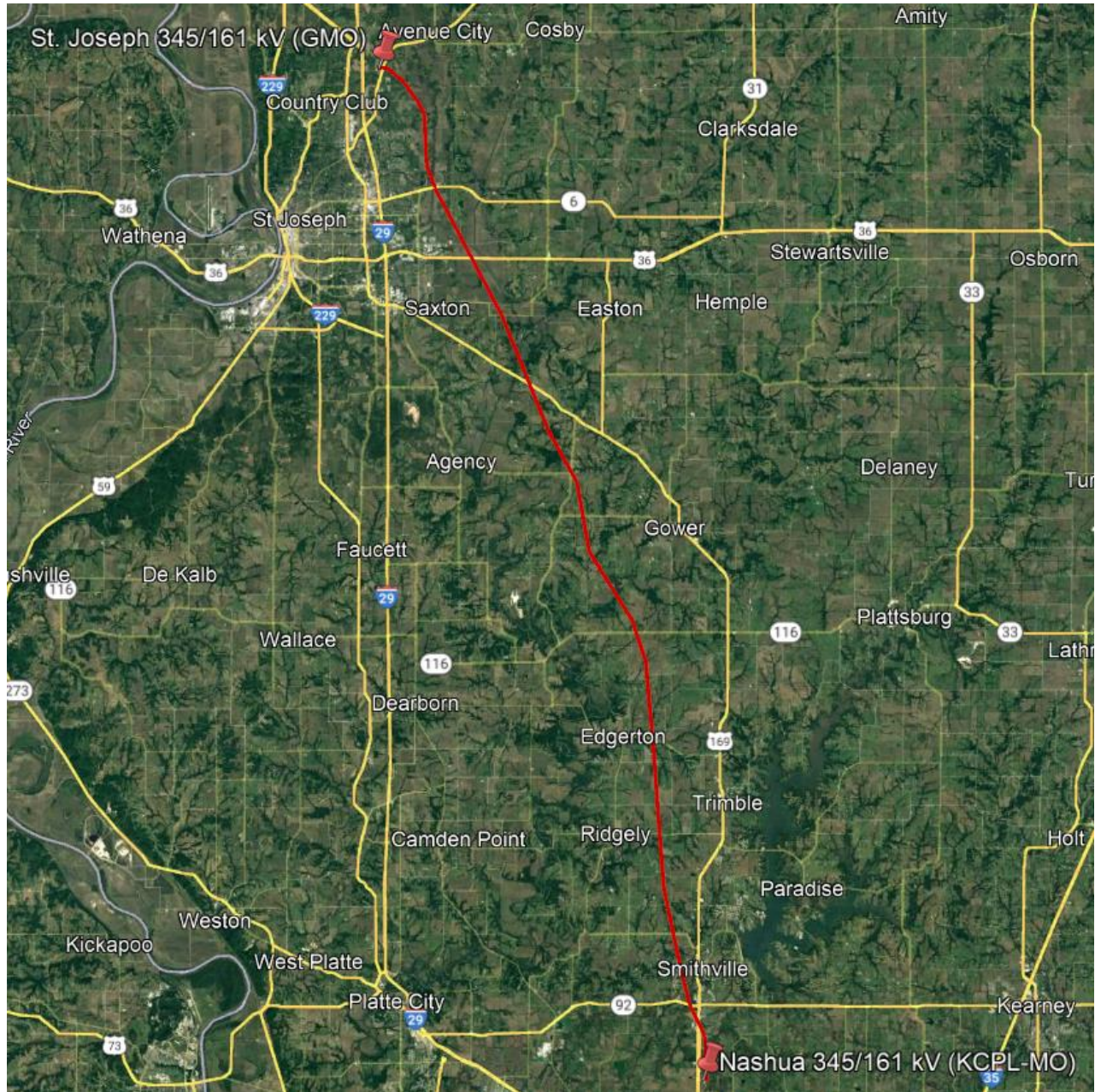

Nashua – St. Joe 345kV GEN-2017-183 Interconnection (TOIF)

345 kV Substation

TOIF requires a new four-terminal substation along the Nashua-St. Joseph 345kV line near the clean-line express right-of-way for GEN-2017-183. The interconnection sub be shared among GEN-2017-183 and GEN-2017-184. UID 143453 and 143455

Total Cost

The total cost estimate for this Interconnection is:

\$	0	345kV Transmission Line
\$	1,225,744	345kV Substation for each
\$	3,677	AFUDC for each
\$	0	Contingency
<hr/>		
\$	1,229,421	Total

This estimate is accurate to +/- twenty (20) percent, based on current prices, in accordance with Attachment A of Appendix 4 of the Interconnection Facilities Study Agreement. However, recent cost fluctuations in materials are very significant and the accuracy of this estimate at the time of actual settings cannot be assured.

Time Estimate

Time estimates are based on current version of the project schedule and some processes of each category run concurrently.

Engineering Time	12-18	Months
Procurement Time	12-18	Months
Construction Time	12	Months
<hr/>		
Total Project Length	36-48	Months

Figure 2 – Nashua – St. Joseph 345kV Line

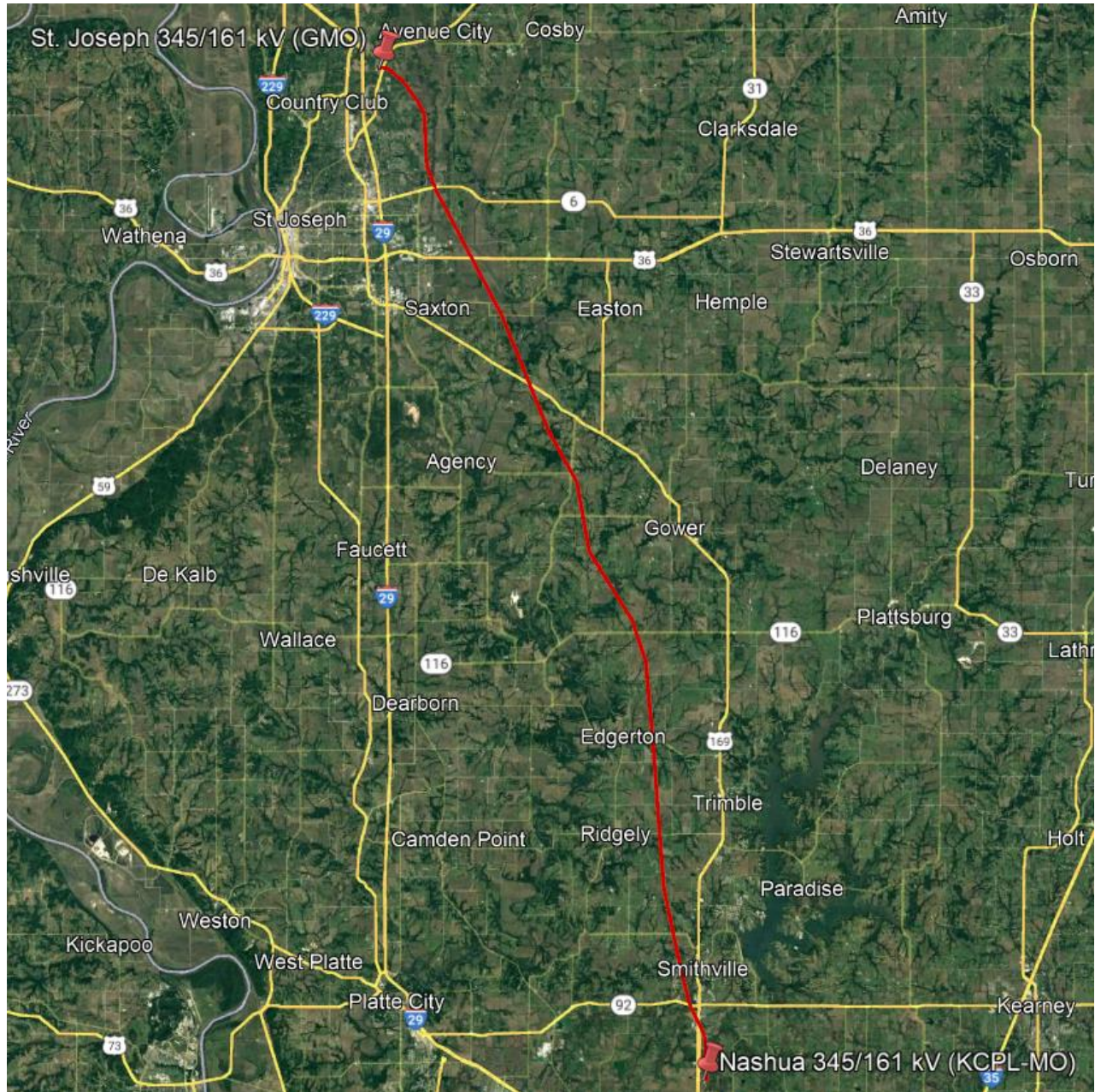

Abilene Energy Center – Northview 115kV GEN-2017-120 Interconnection

(NU) (WERE)

115 kV Substation

Network Upgrades include a new 3-terminal greenfield ring bus substation tapping the Abilene Energy Center-Northview 115kV line (approximately 17.5 mile from Northview 115kV, 4.2 mile from the Abilene EC 115kV). GEN-2017-120 and GEN-2018-013 will be on the same gen-tie fed from this substation. UID 143364

Total Cost

The total cost estimate for this Interconnection is:

\$	1,215,171	115kV Transmission Line
\$	9,394,980	115kV Substation
\$	31,830	AFUDC
\$	0	Contingency
<hr/>		
\$	10,641,983	Total

This estimate is accurate to +/- twenty (20) percent, based on current prices, in accordance with Attachment A of Appendix 4 of the Interconnection Facilities Study Agreement. However, recent cost fluctuations in materials are very significant and the accuracy of this estimate at the time of actual settings cannot be assured.

Time Estimate

Time estimates are based on current version of the project schedule and some processes of each category run concurrently.

Engineering Time	12-18	Months
Procurement Time	12-18	Months
Construction Time	12	Months
<hr/>		
Total Project Length	36-48	Months

Figure 5 – Abilene EC - Northview 115kV Line

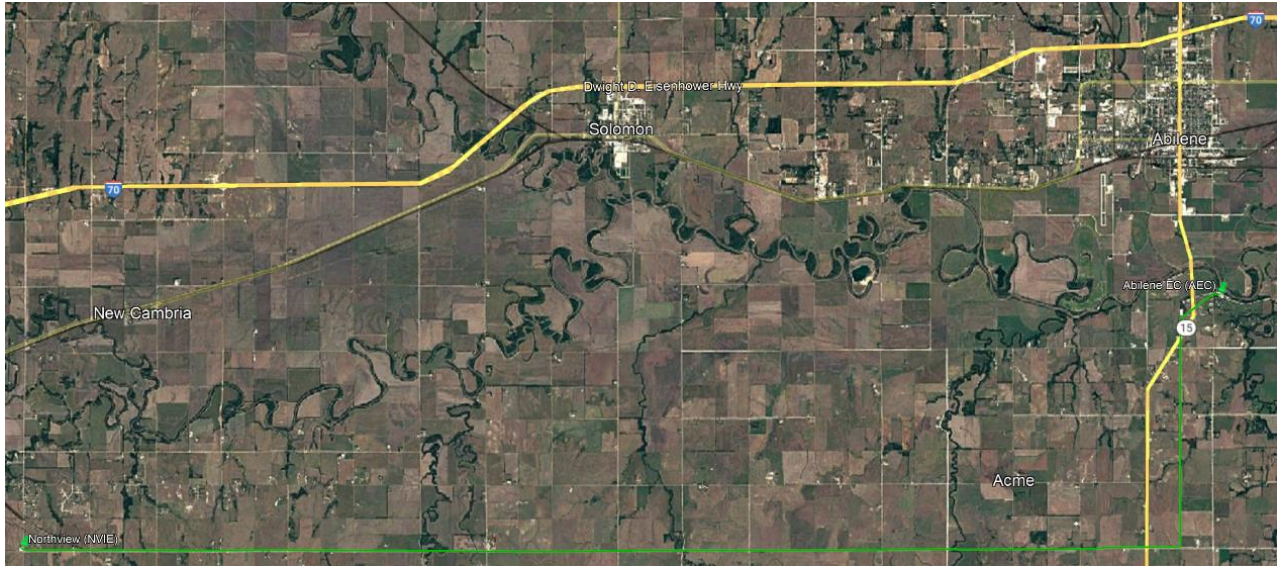

LaCygne – Neosho 345kV GEN 2017-209 Interconnection (Non-Shared NU)
(WERE)

345 kV Substation

This is the network upgrades portion of the Swan solar generator interconnection. It requires a new three-terminal substation along the LaCygne-Neosho 345kV line. UID 143500

Total Cost

The total cost estimate for this Interconnection is:

\$	8,991,464	345kV Transmission Line
\$	21,356,767	345kV Substation
\$	91,044	AFUDC
\$	0	Contingency
<hr/>		
\$	30,439,276	Total

This estimate is accurate to +/- twenty (20) percent, based on current prices, in accordance with Attachment A of Appendix 4 of the Interconnection Facilities Study Agreement. However, recent cost fluctuations in materials are very significant and the accuracy of this estimate at the time of actual settings cannot be assured.

Time Estimate

Time estimates are based on current version of the project schedule and some processes of each category run concurrently.

Engineering Time	12-18	Months
Procurement Time	12-18	Months
Construction Time	12	Months
Total Project Length	36-48	Months

Figure 6 – LaCygne - Neosho 345kV Line



LaCygne – Neosho 345kV GEN 2017-209 Interconnection (Non-Shared TOIF)

(WERE)

345 kV Substation

This is the TOIF portion of the Swan solar generator interconnection. It requires a new three-terminal substation along the LaCygne-Neosho 345kV line. UID 143501

Total Cost

The total cost estimate for this Interconnection is:

\$	0	345kV Transmission Line
\$	1,700,863	345kV Substation
\$	5,102	AFUDC
\$	0	Contingency
<hr/>		
\$	1,705,966	Total

This estimate is accurate to +/- twenty (20) percent, based on current prices, in accordance with Attachment A of Appendix 4 of the Interconnection Facilities Study Agreement. However, recent cost fluctuations in materials are very significant and the accuracy of this estimate at the time of actual settings cannot be assured.

Time Estimate

Time estimates are based on current version of the project schedule and some processes of each category run concurrently.

Engineering Time	12-18	Months
Procurement Time	12-18	Months
Construction Time	12	Months
<hr/>		
Total Project Length	36-48	Months

Figure 7 – LaCygne - Neosho 345kV Line



Archie 161kV Terminal Upgrades (DISIS-2017-002)

161 kV Substation

All terminal equipment to be replaced to meet a 2000 Amp rating. This will require a main bus rebuild to 4" aluminum pipe bus and includes bus side disconnects for the other three line terminals. UID 156516

Total Cost

The total cost estimate for this Network Upgrade is:

\$	0	161kV Transmission Line
\$	1,451,579	161kV Substation
\$	4,354	AFUDC
\$	0	Contingency
<hr/>		
\$	1,455,934	Total

This estimate is accurate to +/- twenty (20) percent, based on current prices, in accordance with Attachment A of Appendix 4 of the Interconnection Facilities Study Agreement. However, recent cost fluctuations in materials are very significant and the accuracy of this estimate at the time of actual settings cannot be assured.

Time Estimate

Time estimates are based on current version of the project schedule and some processes of each category run concurrently.

Engineering Time	12-18	Months
Procurement Time	12-18	Months
Construction Time	12	Months
<hr/>		
Total Project Length	36-48	Months

Figure 9 – Archie 161kV Sub

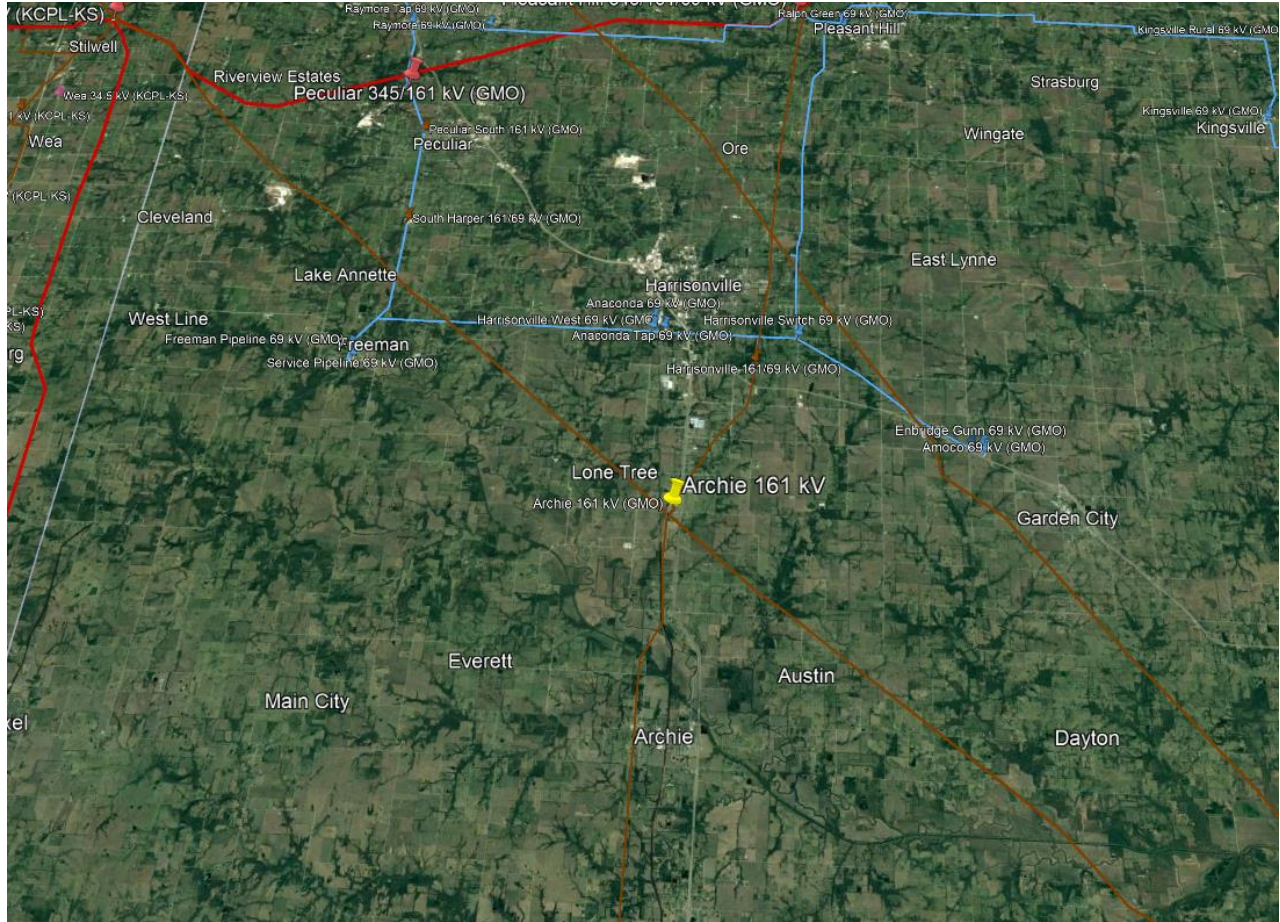

Archie – G17-108 Tap 161 kV Rebuild

161 kV Transmission Line

The estimated cost is for 28.73 miles of 161kV circuit. Line will be rebuilt using steel structures, with angles and dead-ends on drilled piers. Estimate assumes the conductor will be 1192 ACSS/TW and OPGW will be installed. UID 156851

Total Cost

The total cost estimate for this Network Upgrade is:

\$	39,783,750	161 kV Transmission Line
\$	0	161 kV Substation
\$	1,374,210	AFUDC
\$	0	Contingency
<hr/>		
\$	41,157,960	Total

This estimate is accurate to +/- twenty (20) percent, based on current prices, in accordance with Attachment A of Appendix 4 of the Interconnection Facilities Study Agreement. However, recent cost fluctuations in materials are very significant and the accuracy of this estimate at the time of actual settings cannot be assured.

Time Estimate

Time estimates are based on current version of the project schedule and some processes of each category run concurrently.

Engineering Time	12-18	Months
Procurement Time	12-18	Months
Construction Time	12	Months
<hr/>		
Total Project Length	36-48	Months

Figure 10 – Archie – G17-108 Tap

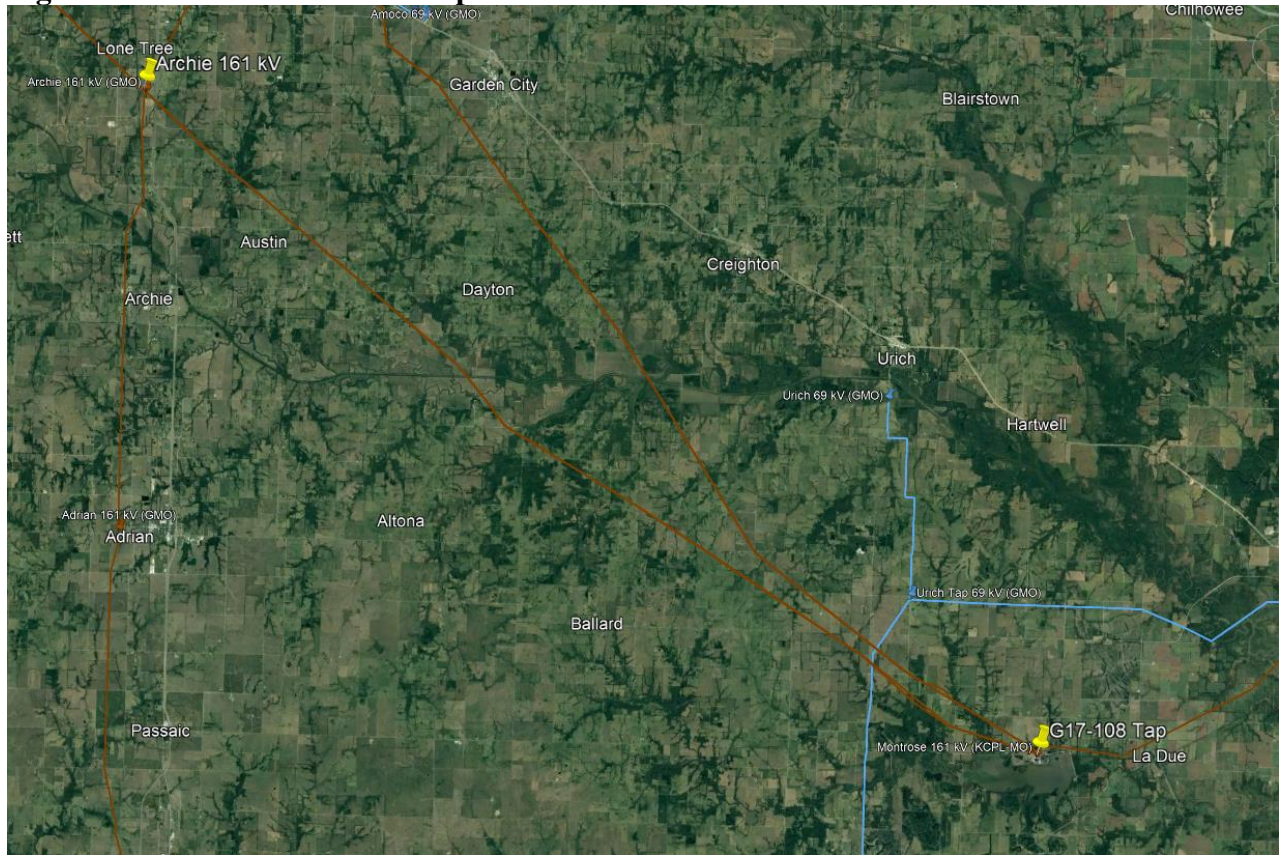

Stilwell – Clinton 161kV New Three (3) Breaker Ring Bus Interconnection Substation (DISIS-2017-002)

161 kV Substation

Network Upgrades include work associated with construction of a three breaker ring bus substation on the Stilwell-Clinton 161 kV Line with three line terminals. UID 143342

Total Cost

The total cost estimate for this Network Upgrade is:

\$	2,205,862	161 kV Transmission Line
\$	9,394,980	161 kV Substation
\$	179,286	AFUDC
\$	0	Contingency
<hr/>		
\$	11,780,129	Total

This estimate is accurate to +/- twenty (20) percent, based on current prices, in accordance with Attachment A of Appendix 4 of the Interconnection Facilities Study Agreement. However, recent cost fluctuations in materials are very significant and the accuracy of this estimate at the time of actual settings cannot be assured.

Time Estimate

Time estimates are based on current version of the project schedule and some processes of each category run concurrently.

Engineering Time	12-18	Months
Procurement Time	12-18	Months
Construction Time	12	Months
<hr/>		
Total Project Length	36-48	Months

Figure 11 – Stilwell – Clinton 161kV Line

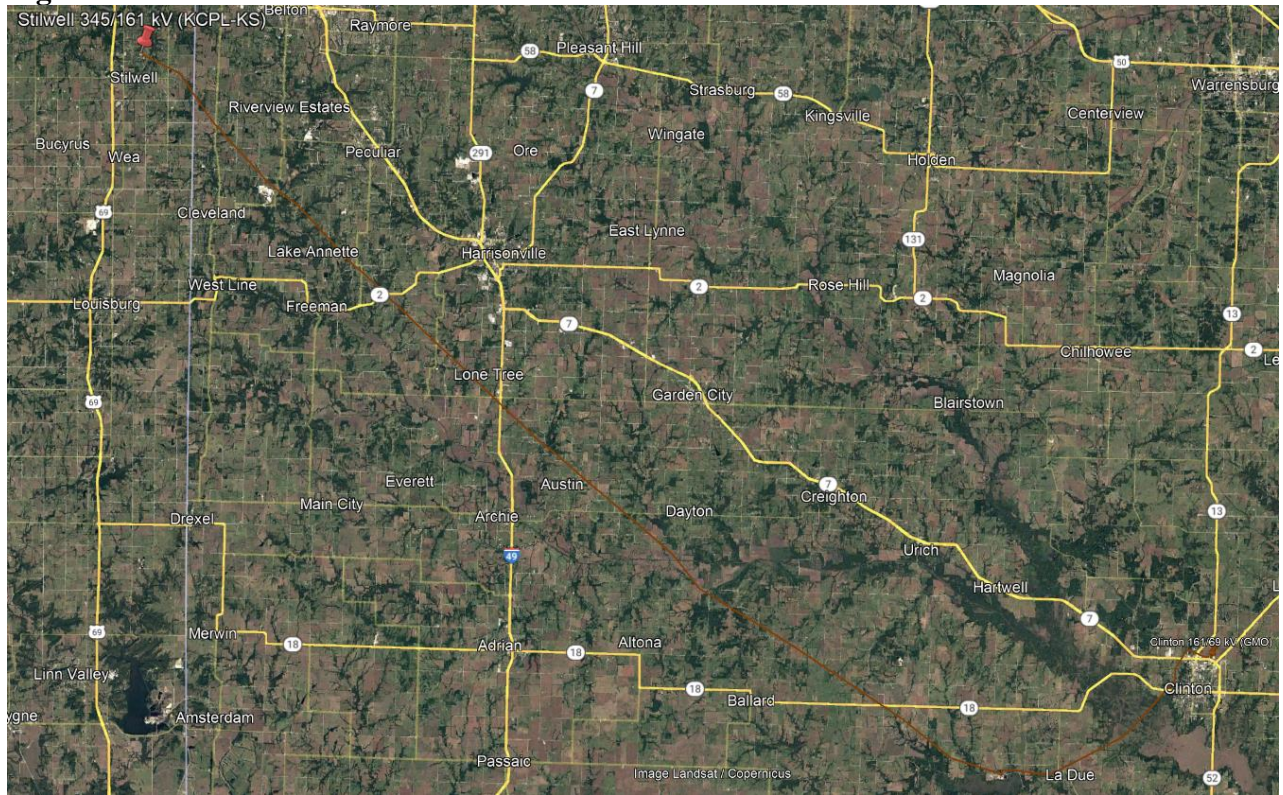

Clinton – Stilwell 161kV GEN-2017-1111 Interconnection (TOIF) (KCPL)

161 kV Substation

TOIF includes construction of a three breaker ring bus substation with three line terminals on the Stilwell-Clinton 161 kV line to accommodate GEN-2017-111. UID 143347

Total Cost

The total cost estimate for this Network Upgrade is:

\$	0	161 kV Transmission Line
\$	629,353	161 kV Substation
\$	1,888	AFUDC
\$	0	Contingency
<hr/>		
\$	631,241	Total

This estimate is accurate to +/- twenty (20) percent, based on current prices, in accordance with Attachment A of Appendix 4 of the Interconnection Facilities Study Agreement. However, recent cost fluctuations in materials are very significant and the accuracy of this estimate at the time of actual settings cannot be assured.

Time Estimate

Time estimates are based on current version of the project schedule and some processes of each category run concurrently.

Engineering Time	12-18	Months
Procurement Time	12-18	Months
Construction Time	12	Months
<hr/>		
Total Project Length	36-48	Months

Stilwell – Clinton 161kV GEN-2017-108 Interconnection (TOIF) (KCPL)

161 kV Substation

TOIF includes construction of a three breaker ring bus substation with three line terminals on the Stilwell-Clinton 161 kV line to accommodate GEN-2017-108. UID 143343

Total Cost

The total cost estimate for this Network Upgrade is:

\$	0	161 kV Transmission Line
\$	629,353	161 kV Substation
\$	1,888	AFUDC

\$	0	Contingency
\$	631,241	Total

This estimate is accurate to +/- twenty (20) percent, based on current prices, in accordance with Attachment A of Appendix 4 of the Interconnection Facilities Study Agreement. However, recent cost fluctuations in materials are very significant and the accuracy of this estimate at the time of actual settings cannot be assured.

Time Estimate

Time estimates are based on current version of the project schedule and some processes of each category run concurrently.

Engineering Time	12-18	Months
Procurement Time	12-18	Months
Construction Time	12	Months
Total Project Length	36-48	Months

Figure 12 – Stilwell – Clinton 161kV Line

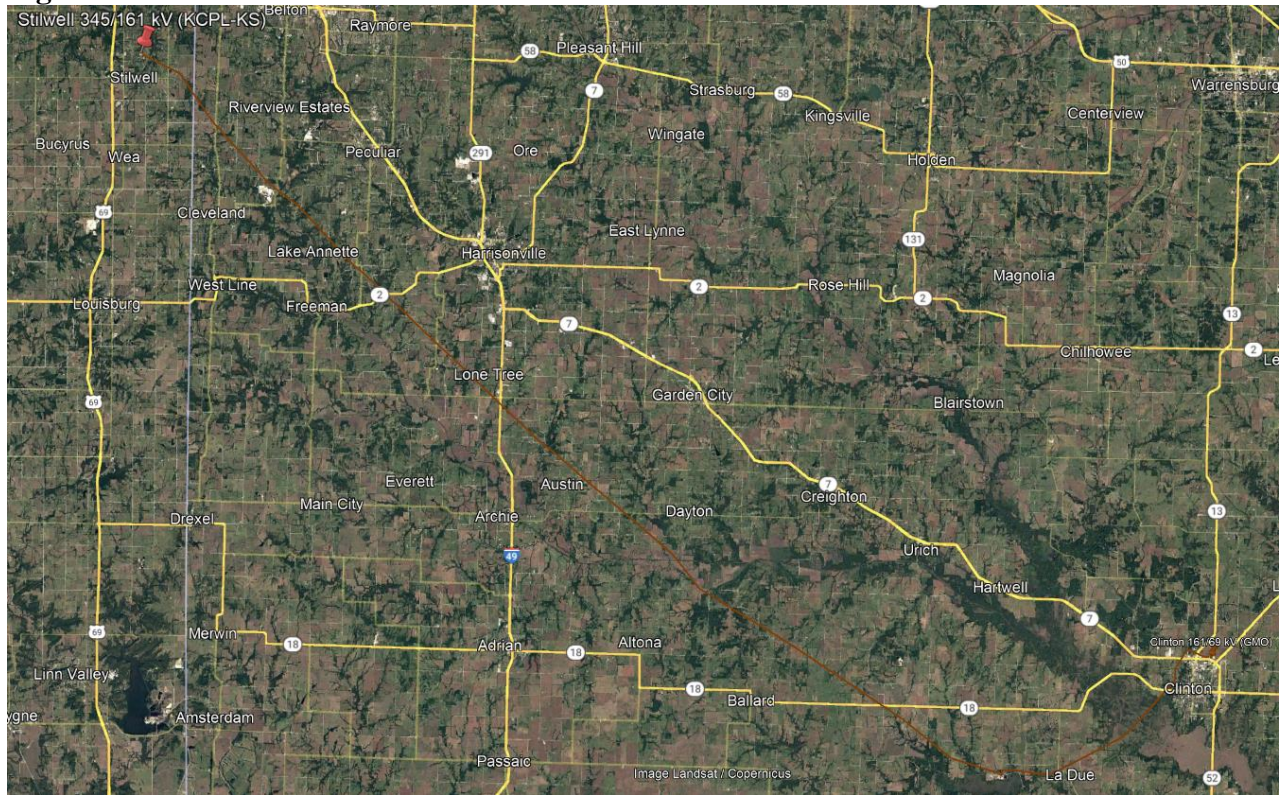

Craig to Lenexa 161 kV Ckt 1 & 2 Rebuild (DISIS-2017-002)

161 kV Transmission Line

The estimated cost is for 2.95 miles of 161kV double circuit. The lines will be rebuilt with steel structures, 1192 ACSS/TW conductor and two OPGW's designed to Evergy standards. UID 156461

Total Cost

The total cost estimate for this Network Upgrade is:

\$	7,763,088	161 kV Transmission Line
\$	0	161 kV Substation
\$	531,771	AFUDC
\$	0	Contingency
<hr/>		
\$	8,294,859	Total

This estimate is accurate to +/- twenty (20) percent, based on current prices, in accordance with Attachment A of Appendix 4 of the Interconnection Facilities Study Agreement. However, recent cost fluctuations in materials are very significant and the accuracy of this estimate at the time of actual settings cannot be assured.

Time Estimate

Time estimates are based on current version of the project schedule and some processes of each category run concurrently.

Engineering Time	12-18	Months
Procurement Time	12-18	Months
Construction Time	12	Months
<hr/>		
Total Project Length	36-48	Months

Post Oak 69-35 kV Transformer Replacement (DISIS-2017-002)

69 kV Transformer

Replace Post Oak 69/35 kV Transformer with a 50MVA 69/34kV Transformer. This will also require a 34kV bank breaker, 34kV feeder breaker, box bay, RTU, control house and metering equipment. UID 156457

Total Cost

The total cost estimate for this Network Upgrade is:

\$	2,788,399	69 kV Substation Transformer
\$	8,365	AFUDC
\$	0	Contingency
<hr/>		
\$	2,796,764	Total

This estimate is accurate to +/- twenty (20) percent, based on current prices, in accordance with Attachment A of Appendix 4 of the Interconnection Facilities Study Agreement. However, recent cost fluctuations in materials are very significant and the accuracy of this estimate at the time of actual settings cannot be assured.

Time Estimate

Time estimates are based on current version of the project schedule and some processes of each category run concurrently.

Engineering Time	12-18	Months
Procurement Time	12-18	Months
Construction Time	12	Months
<hr/>		
Total Project Length	36-48	Months

Figure 14 – Post Oak – 69kV Transformer



Gordon Evans 138kV Interconnection Expansion (DISIS-2017-002)

Gordon Evans 138kV Substation

NU costs associated for adding an additional 138kV terminal to the Gordon Evans CT 138kV substation to accommodate a generator lead. UID 143446

Total Cost

The total cost estimate for this Network Upgrade is:

\$	1,184,282	Line costs
\$	1,230,989	Substation costs
\$	7,245	AFUDC
\$	0	Contingency
<hr/>		
\$	2,422,517	Total

This estimate is accurate to +/- twenty (20) percent, based on current prices, in accordance with Attachment A of Appendix 4 of the Interconnection Facilities Study Agreement. However, recent cost fluctuations in materials are very significant and the accuracy of this estimate at the time of actual settings cannot be assured.

Time Estimate

Time estimates are based on current version of the project schedule and some processes of each category run concurrently.

Engineering Time	12-18	Months
Procurement Time	12-18	Months
Construction Time	12	Months
<hr/>		
Total Project Length	36-48	Months

Figure 15 – Gordon Evans 138kV Sub



Post Oak 34.5kV ASGI-2017- 014 Interconnection (Non-Shared NU)

69/34.5 kV Substation

Network Upgrades include a rebuild of the Post Oak 69/34.5 kV substation with the addition of equipment to support a new 34.5 kV terminal. RTU needs replaced during the rebuild and a bigger control house is needed. UID 143330

Total Cost

The total cost estimate for this Interconnection is:

\$	0	69kV Transmission Line
\$	2,788,399	69kV Substation
\$	8,365	AFUDC
\$	0	Contingency
<hr/>		
\$	2,796,764	Total

This estimate is accurate to +/- twenty (20) percent, based on current prices, in accordance with Attachment A of Appendix 4 of the Interconnection Facilities Study Agreement. However, recent cost fluctuations in materials are very significant and the accuracy of this estimate at the time of actual settings cannot be assured.

Time Estimate

Time estimates are based on current version of the project schedule and some processes of each category run concurrently.

Engineering Time	12-18	Months
Procurement Time	12-18	Months
Construction Time	12	Months
<hr/>		
Total Project Length	36-48	Months

Figure 16 – Post Oak 69kV Sub

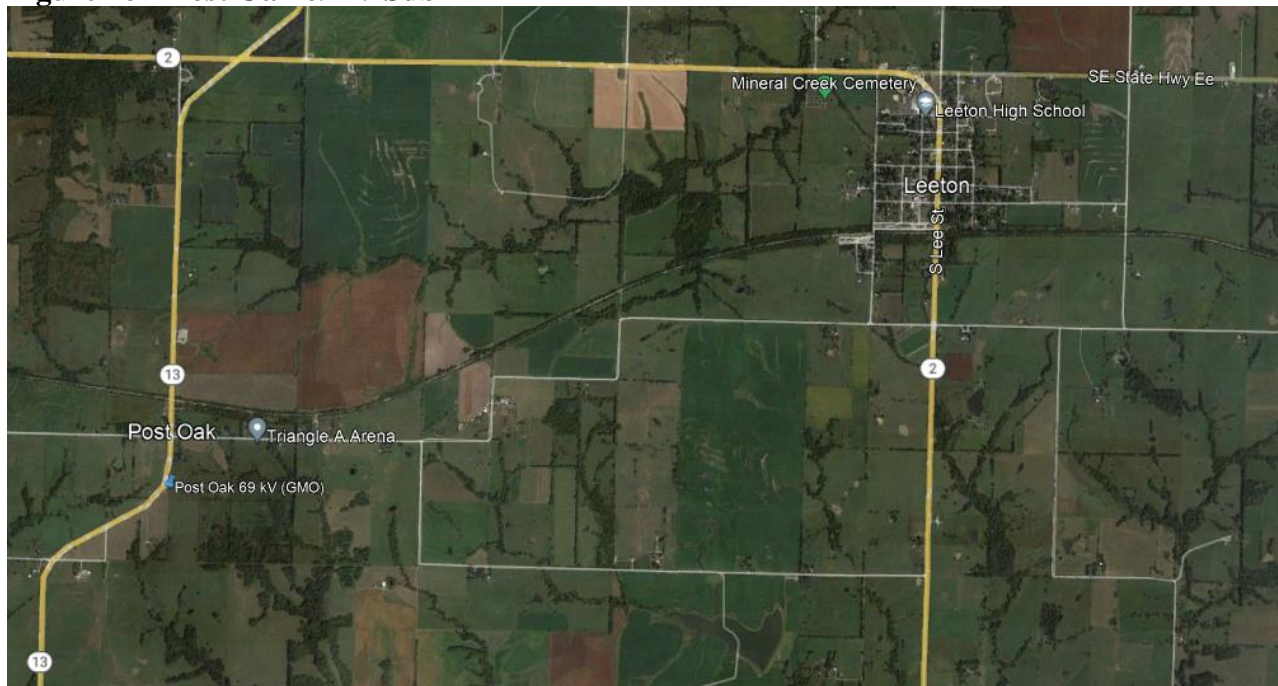

Post Oak 34.5kV ASGI-2017- 014 Interconnection (TOIF)

69/34.5 kV Substation

TOIF includes a new 34.5 kV terminal and metering at Post Oak 69/34.5 kV substation.
UID 143331

Total Cost

The total cost estimate for this Interconnection is:

\$	0	69kV Transmission Line
\$	251,601	69kV Substation
\$	754	AFUDC
\$	0	Contingency
<hr/>		
\$	252,256	Total

This estimate is accurate to +/- twenty (20) percent, based on current prices, in accordance with Attachment A of Appendix 4 of the Interconnection Facilities Study Agreement. However, recent cost fluctuations in materials are very significant and the accuracy of this estimate at the time of actual settings cannot be assured.

Time Estimate

Time estimates are based on current version of the project schedule and some processes of each category run concurrently.

Engineering Time	12-18	Months
Procurement Time	12-18	Months
Construction Time	12	Months
<hr/>		
Total Project Length	36-48	Months

Figure 17 – Post Oak 69kV Sub

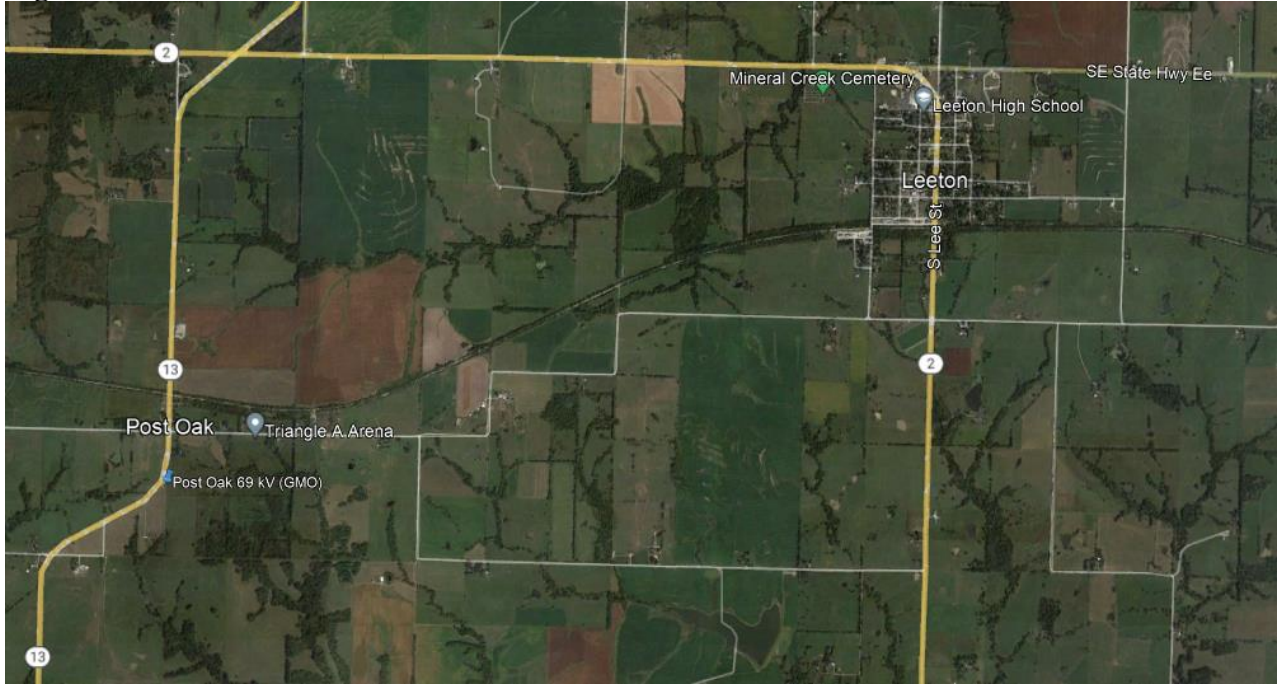

Buffalo Flats 345kV Interconnection Expansion (DISIS-2017-002)

345 kV Substation

Assuming a shared interconnection tie into the Buffalo Flats 345kV substation for requests GEN-2017-220 and GEN-2017-221. One open terminal on existing rung but will potentially be used by GEN-2016-073 if it moves forward. If that terminal is taken, another rung would be required. May be able to expand substation to the west but would need to relocate existing interconnection tie into substation. UID 143518

Total Cost

The total cost estimate for this Interconnection is:

\$	0	345kV Transmission Line
\$	2,280,289	345kV Substation
\$	6,840	AFUDC
\$	0	Contingency
<hr/>		
\$	2,287,129	Total

This estimate is accurate to +/- twenty (20) percent, based on current prices, in accordance with Attachment A of Appendix 4 of the Interconnection Facilities Study Agreement. However, recent cost fluctuations in materials are very significant and the accuracy of this estimate at the time of actual settings cannot be assured.

Time Estimate

Time estimates are based on current version of the project schedule and some processes of each category run concurrently.

Engineering Time	12-18	Months
Procurement Time	12-18	Months
Construction Time	12	Months
<hr/>		
Total Project Length	36-48	Months

Figure 18 – Buffalo Flats 345kV Sub

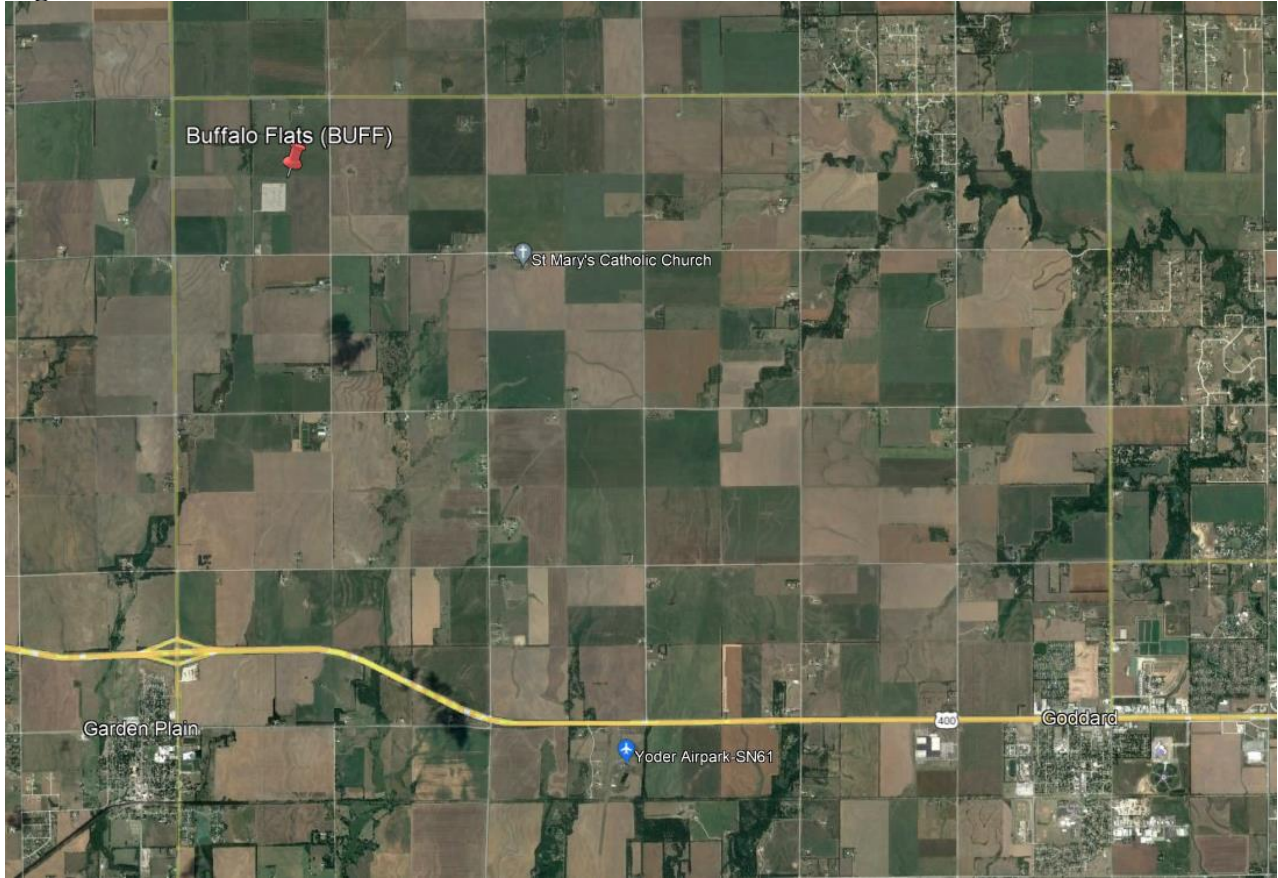

West Gardner 345kV Interconnection Expansion (DISIS-2017-002)

345 kV Substation

Network Upgrades associated with the interconnection of GEN-2017-195. The POI is West Gardner 345kV. Currently Marmaton I and II wind farms have a GIA that requires West Gardner to be built as breaker and a half, the costs below reflect the Marmaton I and II completing their GI. GEN-2017-195 will share costs with GEN-2017-196 as they are sharing a generation tie to West Gardner 345kV. UID 143476

Total Cost

The total cost estimate for this Interconnection is:

\$	2,152,819	345kV Substation
\$	6,459	AFUDC for each
\$	0	Contingency
<hr/>		
\$	2,159,278	Total

This estimate is accurate to +/- twenty (20) percent, based on current prices, in accordance with Attachment A of Appendix 4 of the Interconnection Facilities Study Agreement. However, recent cost fluctuations in materials are very significant and the accuracy of this estimate at the time of actual settings cannot be assured.

Time Estimate

Time estimates are based on current version of the project schedule and some processes of each category run concurrently.

Engineering Time	12-18	Months
Procurement Time	12-18	Months
Construction Time	12	Months
<hr/>		
Total Project Length	36-48	Months

Figure 19 – West Gardner 345kV Sub

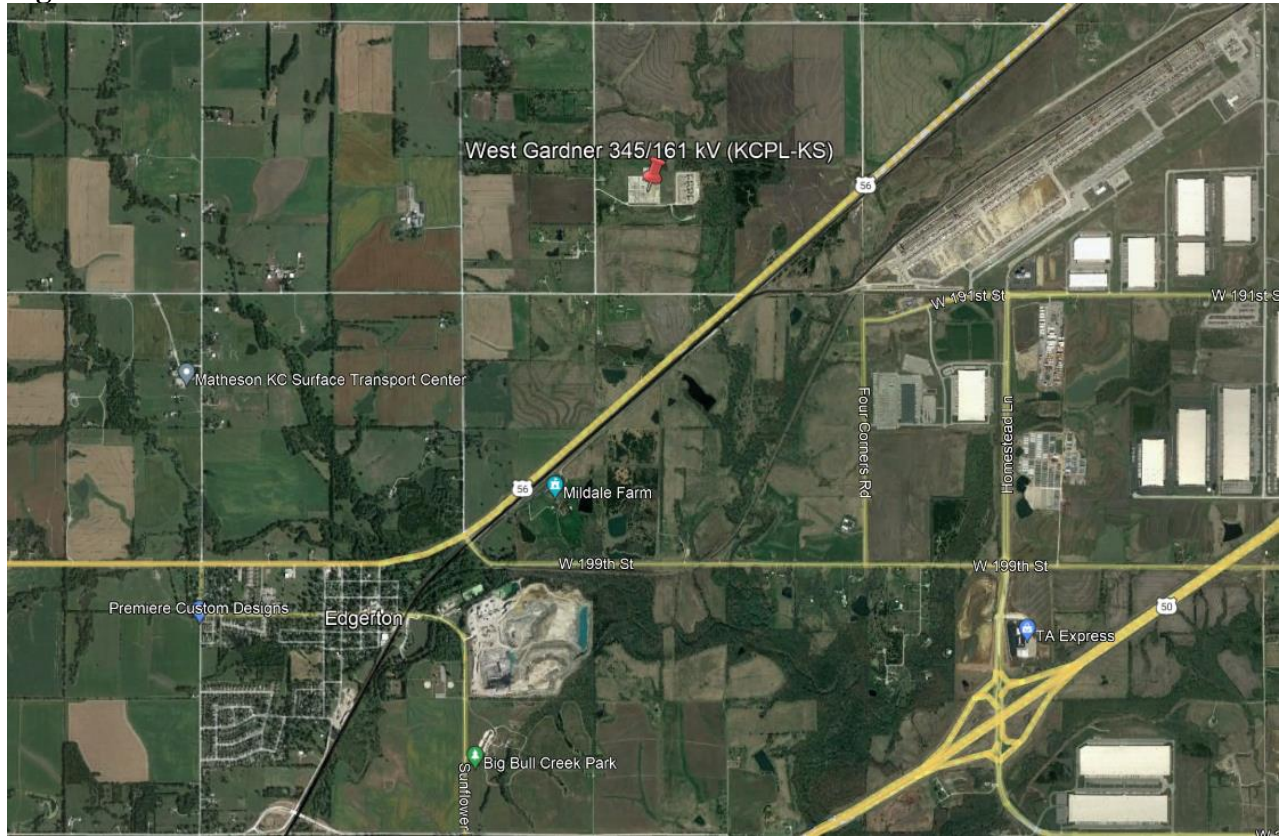

West Gardner 345kV GEN-2017-195 & 196 Interconnection Expansion TOIF

345 kV Substation

TOIF costs associated with the interconnection of GEN-2017-195. The POI is West Gardner 345kV. Currently Marmaton I and II wind farms have a GIA that requires West Gardner to be built as breaker and a half. This interconnection will share costs with GEN-2017-196 as they are sharing a generation tie to West Gardner 345kV. UID 143477 & 143479

Total Cost

The total cost estimate for this Interconnection is:

\$	944,204	345kV Substation for each
\$	2,832	AFUDC for each
\$	0	Contingency
<hr/>		
\$	947,037	Total

This estimate is accurate to +/- twenty (20) percent, based on current prices, in accordance with Attachment A of Appendix 4 of the Interconnection Facilities Study Agreement. However, recent cost fluctuations in materials are very significant and the accuracy of this estimate at the time of actual settings cannot be assured.

Time Estimate

Time estimates are based on current version of the project schedule and some processes of each category run concurrently.

Engineering Time	12-18	Months
Procurement Time	12-18	Months
Construction Time	12	Months
<hr/>		
Total Project Length	36-48	Months

Figure 20 – West Gardner 345kV Sub

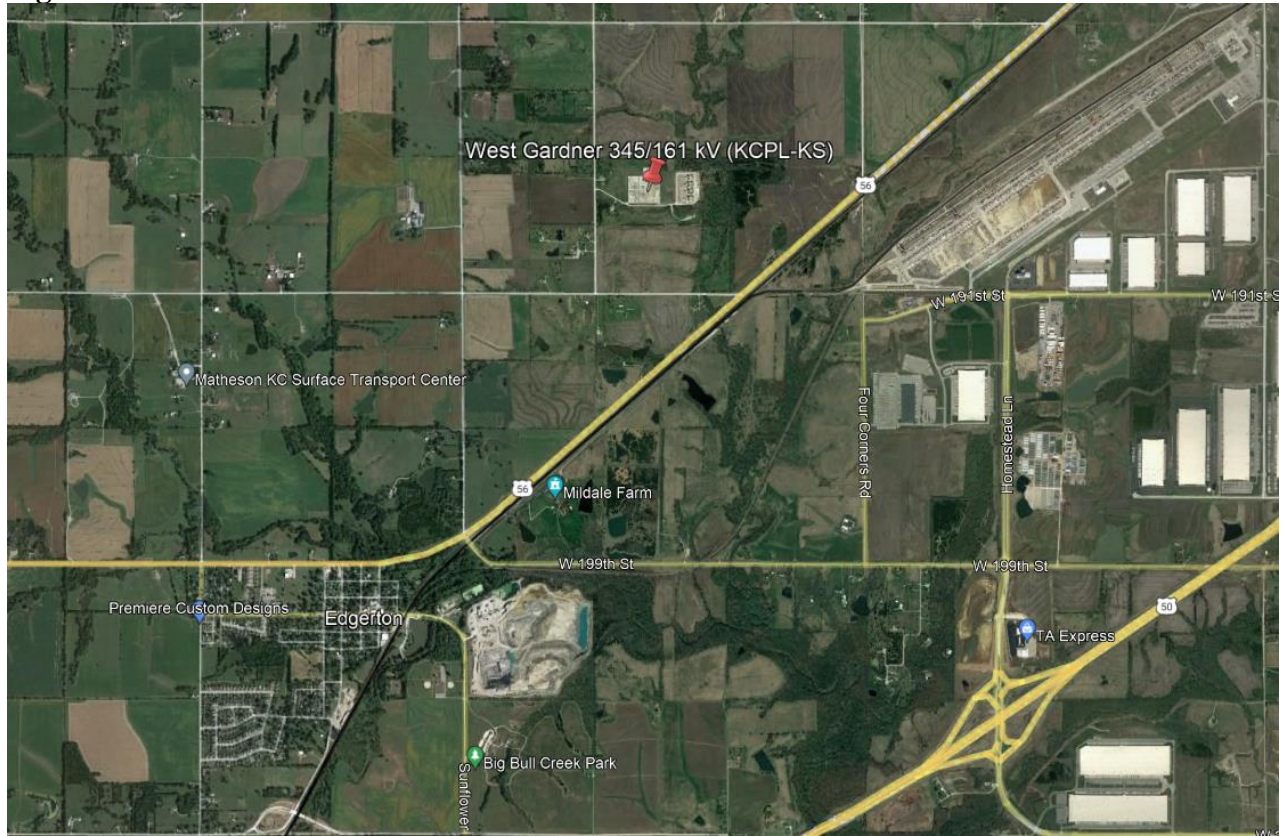

Buffalo Flats 345kV GEN-2017-220 Interconnection (TOIF) (WERE)

345 kV Substation

Assuming a shared interconnection tie into the Buffalo Flats 345kV substation for requests GEN-2017-220 and GEN-2017-221. One open terminal on existing rung but will potentially be used by GEN-2016-073 if it moves forward. If that terminal is taken, another rung would be required. May be able to expand substation to the west but would need to relocate existing interconnection tie into substation. UID 143519 and 143521

Total Cost

The total cost estimate for this Interconnection is:

\$	0	345kV Transmission Line
\$	1,155,206	345kV Substation
\$	3,465	AFUDC
\$	0	Contingency
<hr/>		
\$	1,158,671	Total

This estimate is accurate to +/- twenty (20) percent, based on current prices, in accordance with Attachment A of Appendix 4 of the Interconnection Facilities Study Agreement. However, recent cost fluctuations in materials are very significant and the accuracy of this estimate at the time of actual settings cannot be assured.

Time Estimate

Time estimates are based on current version of the project schedule and some processes of each category run concurrently.

Engineering Time	12-18	Months
Procurement Time	12-18	Months
Construction Time	12	Months
<hr/>		
Total Project Length	36-48	Months

Figure 22 – Buffalo Flats 345kV Sub

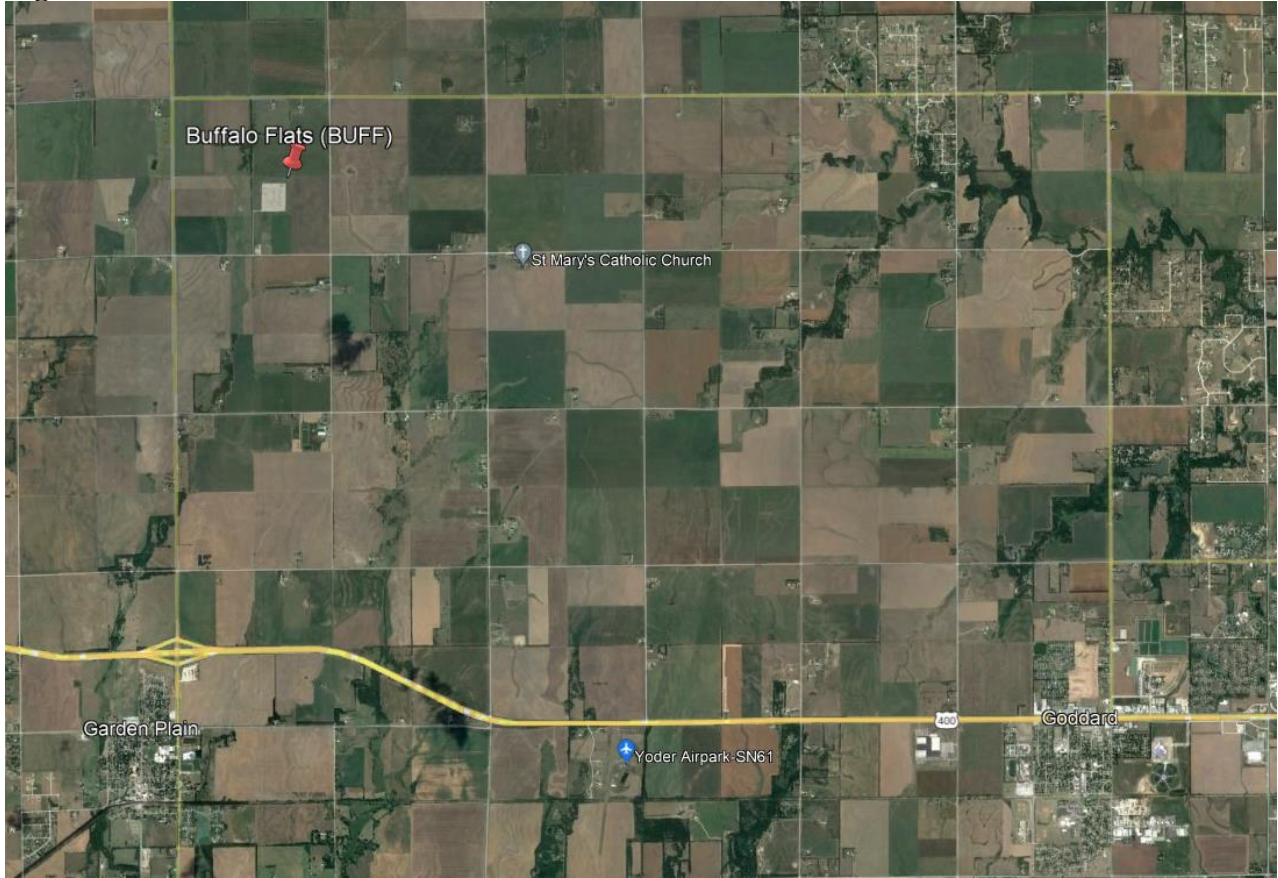

West Gardner 345kV GEN-2017-195 & 196 Interconnection TOIF

345kV Substation Expansion

TOIF costs associated with the interconnection include shielded cabling, bus conductor and tubing and labor. This interconnection will share costs with GEN-2017-195 and 196, as they will be on the same generation tie at the West Gardner 345kV substation. UID 143477 and 143479

Total Cost

The total cost estimate for this TOIF is:

\$	944,204	Substation costs for each
\$	2,832	AFUDC for each
\$	0	Contingency
<hr/>		
\$	947,036	Total

This estimate is accurate to +/- twenty (20) percent, based on current prices, in accordance with Attachment A of Appendix 4 of the Interconnection Facilities Study Agreement. However, recent cost fluctuations in materials are very significant and the accuracy of this estimate at the time of actual settings cannot be assured.

Time Estimate

Time estimates are based on current version of the project schedule and some processes of each category run concurrently.

Engineering Time	12-18	Months
Procurement Time	12-18	Months
Construction Time	12	Months
<hr/>		
Total Project Length	36-48	Months

Figure 24 – West Gardner 345kV substation



Swissvale 345kV Interconnection Expansion (DISIS-2017-002)

345kV Substation expansion

Network upgrade costs associated with an interconnection expansion to accommodate the interconnection of GEN-2017-125, GEN-2017-128, GEN-2017-191 and GEN-2017-192. This includes site expansion, construction of a new 345kV 4 rung breaker and half with a new equipment enclosure. Equipment will include breakers, switches, VTs, CCVTs, steel, bus and other miscellaneous equipment at the Swissvale 345kV substation. This estimate includes terminal equipment for two line terminals (Emporia EC and Kansas City) and two for 138/230kV Transformers. These costs will be shared by GEN-2017-125, 128, 191 and 192. UID 143370

Total Cost

The total cost estimate for this Network Upgrade is:

\$	1,768,500	Line Costs
\$	23,720,681	Substation costs
\$	76,467	AFUDC
\$	0	Contingency
<hr/>		
\$	25,565,648	Total

This estimate is accurate to +/- twenty (20) percent, based on current prices, in accordance with Attachment A of Appendix 4 of the Interconnection Facilities Study Agreement. However, recent cost fluctuations in materials are very significant and the accuracy of this estimate at the time of actual settings cannot be assured.

Time Estimate

Time estimates are based on current version of the project schedule and some processes of each category run concurrently.

Engineering Time	12-18	Months
Procurement Time	12-18	Months
Construction Time	12	Months
<hr/>		
Total Project Length	36-48	Months

Swissvale 345kV GEN-2017-125 & 128 Interconnection TOIF

345kV Substation

TOIF costs associated with the interconnection include two new terminals and metering at the Swissvale 345kV substation. Cost assumes there is an existing 345kV breaker and half with existing control enclosure. Line steel and miscellaneous equipment (VTs, 3CTs and dead end) are also included. These costs will be shared by GEN-2017-125 and 128. UID 143371 and 143373

Total Cost

The total cost estimate for this TOIF is:

\$	2,550,249	Substation costs
\$	7,650	AFUDC
\$	0	Contingency
<hr/>		
\$	2,557,900	Total

This estimate is accurate to +/- twenty (20) percent, based on current prices, in accordance with Attachment A of Appendix 4 of the Interconnection Facilities Study Agreement. However, recent cost fluctuations in materials are very significant and the accuracy of this estimate at the time of actual settings cannot be assured.

Time Estimate

Time estimates are based on current version of the project schedule and some processes of each category run concurrently.

Engineering Time	12-18	Months
Procurement Time	12-18	Months
Construction Time	12	Months
<hr/>		
Total Project Length	36-48	Months

Swissvale 345kV GEN-2017-191 & 192 Interconnection TOIF

345kV Substation

TOIF costs associated with the interconnection include a new terminal and metering at the Swissvale 345kV substation. The estimate assumes there is an existing 345kV breaker and half substation with existing control enclosure. Line steel and miscellaneous equipment (VTs, 3CTs and dead end) are also included. These costs will be shared by GEN-2017-191 and 192. UID 143469 and 143471

Total Cost

The total cost estimate for this TOIF is:

\$	1,275,125	Substation costs
\$	3,825	AFUDC
\$	0	Contingency
<hr/>		
\$	1,278,950	Total

This estimate is accurate to +/- twenty (20) percent, based on current prices, in accordance with Attachment A of Appendix 4 of the Interconnection Facilities Study Agreement. However, recent cost fluctuations in materials are very significant and the accuracy of this estimate at the time of actual settings cannot be assured.

Time Estimate

Time estimates are based on current version of the project schedule and some processes of each category run concurrently.

Engineering Time	12-18	Months
Procurement Time	12-18	Months
Construction Time	12	Months
<hr/>		
Total Project Length	36-48	Months

Figure 25 – Swissvale 345kV Substation



Abilene Energy Center – Northview 115kV GEN-2017-120 Interconnection

TOIF

Abilene Energy Center – Northview 115kV line

TOIF costs associated with the interconnection a new terminal and metering at the new 115kV interconnection substation. UID 143365

Total Cost

The total cost estimate for this TOIF is:

\$	840,193	Substation costs
\$	2,520	AFUDC
\$	0	Contingency
<hr/>		
\$	842,713	Total

This estimate is accurate to +/- twenty (20) percent, based on current prices, in accordance with Attachment A of Appendix 4 of the Interconnection Facilities Study Agreement. However, recent cost fluctuations in materials are very significant and the accuracy of this estimate at the time of actual settings cannot be assured.

Time Estimate

Time estimates are based on current version of the project schedule and some processes of each category run concurrently.

Engineering Time	12-18	Months
Procurement Time	12-18	Months
Construction Time	12	Months
<hr/>		
Total Project Length	36-48	Months

Figure 26 – Abilene Energy Center – Northview 115kV line



Stilwell 345kV GEN-2017-229 Interconnection NU

Stilwell 345kV Substation

NU costs associated with the interconnection includes a rebuild of the Stilwell 345kV substation as a breaker and a half configuration with 7 terminals. This request includes two new 345kV gen lines interconnection at Stilwell 345kV substation. Stilwell 161kV will also have to be rebuilt to accommodate the new 345kV terminals. UID 143534

Total Cost

The total cost estimate for this Network Upgrade is:

\$	5,152,000	Line Costs
\$	72,351,043	Substation costs
\$	196,224	AFUDC
\$	0	Contingency
<hr/>		
\$	78,073,007	Total

This estimate is accurate to +/- twenty (20) percent, based on current prices, in accordance with Attachment A of Appendix 4 of the Interconnection Facilities Study Agreement. However, recent cost fluctuations in materials are very significant and the accuracy of this estimate at the time of actual settings cannot be assured.

Time Estimate

Time estimates are based on current version of the project schedule and some processes of each category run concurrently.

Engineering Time	12-18	Months
Procurement Time	12-18	Months
Construction Time	12	Months
<hr/>		
Total Project Length	36-48	Months

Stilwell 345kV GEN-2017-229 Interconnection TOIF

Stilwell 345kV Substation

TOIF costs associated with the interconnection a new terminal and metering at Stilwell 345kV substation. UID 143435

Total Cost

The total cost estimate for this TOIF is:

\$	1,337,344	Substation costs
----	-----------	------------------

\$	4,012	AFUDC
\$	0	Contingency
<hr/>		
\$	1,341,356	Total

This estimate is accurate to +/- twenty (20) percent, based on current prices, in accordance with Attachment A of Appendix 4 of the Interconnection Facilities Study Agreement. However, recent cost fluctuations in materials are very significant and the accuracy of this estimate at the time of actual settings cannot be assured.

Time Estimate

Time estimates are based on current version of the project schedule and some processes of each category run concurrently.

Engineering Time	12-18	Months
Procurement Time	12-18	Months
Construction Time	12	Months
<hr/>		
Total Project Length	36-48	Months

Figure 28 – Stilwell 345 kV substation



Holt 345kV GEN-2017-115 Interconnection NU

Holt 345kV Substation

NU costs associated with the interconnection includes a breaker that will be added to the ring bus, terminal, and metering at the Holt County 345kV substation. UID 143354

Total Cost

The total cost estimate for this Network Upgrade is:

\$	1,013,554	Substation costs
\$	3,040	AFUDC
\$	0	Contingency
<hr/>		
\$	1,016,595	Total

This estimate is accurate to +/- twenty (20) percent, based on current prices, in accordance with Attachment A of Appendix 4 of the Interconnection Facilities Study Agreement. However, recent cost fluctuations in materials are very significant and the accuracy of this estimate at the time of actual settings cannot be assured.

Time Estimate

Time estimates are based on current version of the project schedule and some processes of each category run concurrently.

Engineering Time	12-18	Months
Procurement Time	12-18	Months
Construction Time	12	Months
<hr/>		
Total Project Length	36-48	Months

Holt 345kV GEN-2017-115 Interconnection TOIF

Holt 345kV Substation

TOIF costs associated with the interconnection includes a terminal and metering, for the new breaker, at the Holt County 345kV substation. UID 143355

Total Cost

The total cost estimate for this TOIF is:

\$	644,643	Substation costs
\$	1,934	AFUDC
\$	0	Contingency
<hr/>		
\$	646,577	Total

This estimate is accurate to +/- twenty (20) percent, based on current prices, in accordance with Attachment A of Appendix 4 of the Interconnection Facilities Study Agreement. However, recent cost fluctuations in materials are very significant and the accuracy of this estimate at the time of actual settings cannot be assured.

Time Estimate

Time estimates are based on current version of the project schedule and some processes of each category run concurrently.

Engineering Time	12-18	Months
Procurement Time	12-18	Months
Construction Time	12	Months
<hr/>		
Total Project Length	36-48	Months

Figure 29 – Holt 345kV Substation



Sumner County 138kV GEN-2017-121 Interconnection (Non-Shared NU)

Sumner County 138kV Substation

NU costs associated with the interconnection include a new 138kV breaker and associated equipment for additional terminal at Sumner County 138kV Substation. UID 143366

Total Cost

The total cost estimate for this Network Upgrade is:

\$	589,796	Substation costs
\$	1,769	AFUDC
\$	0	Contingency
<hr/>		
\$	591,566	Total

This estimate is accurate to +/- twenty (20) percent, based on current prices, in accordance with Attachment A of Appendix 4 of the Interconnection Facilities Study Agreement. However, recent cost fluctuations in materials are very significant and the accuracy of this estimate at the time of actual settings cannot be assured.

Time Estimate

Time estimates are based on current version of the project schedule and some processes of each category run concurrently.

Engineering Time	12-18	Months
Procurement Time	12-18	Months
Construction Time	12	Months
<hr/>		
Total Project Length	36-48	Months

Sumner County 138kV GEN-2017-121 Interconnection (TOIF)

Sumner County 138kV Substation

TOIF costs associated with the interconnection include a new terminal and metering at the Sumner County 138kV substation. UID 143367

Total Cost

The total cost estimate for this TOIF is:

\$	646,577	Substation costs
\$	1,939	AFUDC
\$	0	Contingency
<hr/>		
\$	648,517	Total

This estimate is accurate to +/- twenty (20) percent, based on current prices, in accordance with Attachment A of Appendix 4 of the Interconnection Facilities Study Agreement. However, recent cost fluctuations in materials are very significant and the accuracy of this estimate at the time of actual settings cannot be assured.

Time Estimate

Time estimates are based on current version of the project schedule and some processes of each category run concurrently.

Engineering Time	12-18	Months
Procurement Time	12-18	Months
Construction Time	12	Months
<hr/>		
Total Project Length	36-48	Months

Figure 32 – Sumner County 138kV Substation



Gordon Evans 138kV GEN-2017-179 Interconnection (TOIF)

Gordon Evans 138kV Substation

TOIF costs associated with the interconnection facilities. This interconnection will for GEN-2017-179 tie that connects to Gordon Evans 138kV substation. UID 143447

Total Cost

The total cost estimate for this TOIF is:

\$	714,908	Substation costs
\$	2,144	AFUDC
\$	0	Contingency
<hr/>		
\$	717,053	Total

This estimate is accurate to +/- twenty (20) percent, based on current prices, in accordance with Attachment A of Appendix 4 of the Interconnection Facilities Study Agreement. However, recent cost fluctuations in materials are very significant and the accuracy of this estimate at the time of actual settings cannot be assured.

Time Estimate

Time estimates are based on current version of the project schedule and some processes of each category run concurrently.

Engineering Time	12-18	Months
Procurement Time	12-18	Months
Construction Time	12	Months
<hr/>		
Total Project Length	36-48	Months

Gordon Evans 138kV GEN-2017-226 & 227 Interconnection (TOIF)

Gordon Evans 138kV Substation

TOIF costs associated with the interconnection include a substation expansion and new 138kV rung. This interconnection will share costs by GEN-2017-226 and GEN-2017-227 as they will share a generation tie that connects to Gordon Evans 138kV substation. UID 143529 and 143531

Total Cost

The total cost estimate for this TOIF is:

\$	742,533	Substation costs
\$	2,227	AFUDC
\$	0	Contingency
<hr/>		
\$	744,761	Total

This estimate is accurate to +/- twenty (20) percent, based on current prices, in accordance with Attachment A of Appendix 4 of the Interconnection Facilities Study Agreement. However, recent cost fluctuations in materials are very significant and the accuracy of this estimate at the time of actual settings cannot be assured.

Time Estimate

Time estimates are based on current version of the project schedule and some processes of each category run concurrently.

Engineering Time	12-18	Months
Procurement Time	12-18	Months
Construction Time	12	Months
<hr/>		
Total Project Length	36-48	Months

Figure 33 – Gordon Evans 138kV Substation



Altoona – NE Parsons 138kV GEN-2017-131 Interconnection (NU)

Altoona – NE Parsons 138kV Substation

Assuming interconnection of GEN-2017-022, network upgrade costs associated with the interconnection include a relay settings only. These costs assumes successful connection of GEN-2017-022. UID 143374

Total Cost

The total cost estimate for this Network Upgrade is:

\$	12,344	Substation costs
\$	37	AFUDC
\$	0	Contingency
<hr/>		
\$	12,381	Total

This estimate is accurate to +/- twenty (20) percent, based on current prices, in accordance with Attachment A of Appendix 4 of the Interconnection Facilities Study Agreement.

However, recent cost fluctuations in materials are very significant and the accuracy of this estimate at the time of actual settings cannot be assured.

Time Estimate

Time estimates are based on current version of the project schedule and some processes of each category run concurrently.

Engineering Time	12-18	Months
Procurement Time	12-18	Months
Construction Time	12	Months
<hr/> Total Project Length	36-48	Months

Altoona – NE Parsons 138kV GEN-2017-131 Interconnection (TOIF)

Altoona – NE Parsons 138kV Substation

Assuming interconnection of GEN-2017-022, TOIF costs associated with the interconnection include a daisy chained request. These costs assumes successful connection of GEN-2017-022. UID 143375

Total Cost

The total cost estimate for this TOIF is:

\$	24,688	Substation costs
\$	74	AFUDC
\$	0	Contingency
<hr/> <hr/>		
\$	24,762	Total

This estimate is accurate to +/- twenty (20) percent, based on current prices, in accordance with Attachment A of Appendix 4 of the Interconnection Facilities Study Agreement. However, recent cost fluctuations in materials are very significant and the accuracy of this estimate at the time of actual settings cannot be assured.

Time Estimate

Time estimates are based on current version of the project schedule and some processes of each category run concurrently.

Engineering Time	2	Months
Procurement Time	2	Months
Construction Time	2	Months
<hr/> Total Project Length	6	Months

Figure 34 – Altoona – NE Parsons 138kV Line



Viola – Renfrow 345 kV Rebuild (Evergy Portion)

345 kV Transmission Line

The estimated cost is for the rebuild of the 23-mile Evergy portion of the Viola – Renfrow 345kV line to meet a 3000 Amp line rating. Line will be rebuilt using steel structures, with angles and dead-ends on drilled piers. Estimate assumes the conductor will be 1590 Lapwing ACSR and OPGW will be installed. UID 156471

Total Cost

The total cost estimate for this Network Upgrade is:

\$	47,276,805	345 kV Transmission Line
\$	0	345 kV Substation
\$	141,830	AFUDC
\$	0	Contingency
<hr/>		
\$	47,418,635	Total

This estimate is accurate to +/- twenty (20) percent, based on current prices, in accordance with Attachment A of Appendix 4 of the Interconnection Facilities Study Agreement. However, recent cost fluctuations in materials are very significant and the accuracy of this estimate at the time of actual settings cannot be assured.

Time Estimate

Time estimates are based on current version of the project schedule and some processes of each category run concurrently.

Engineering Time	12-18	Months
Procurement Time	12-18	Months
Construction Time	12	Months

Total Project Length

36-48

Months

Figure 35 – Viola – Renfrow 345 kV

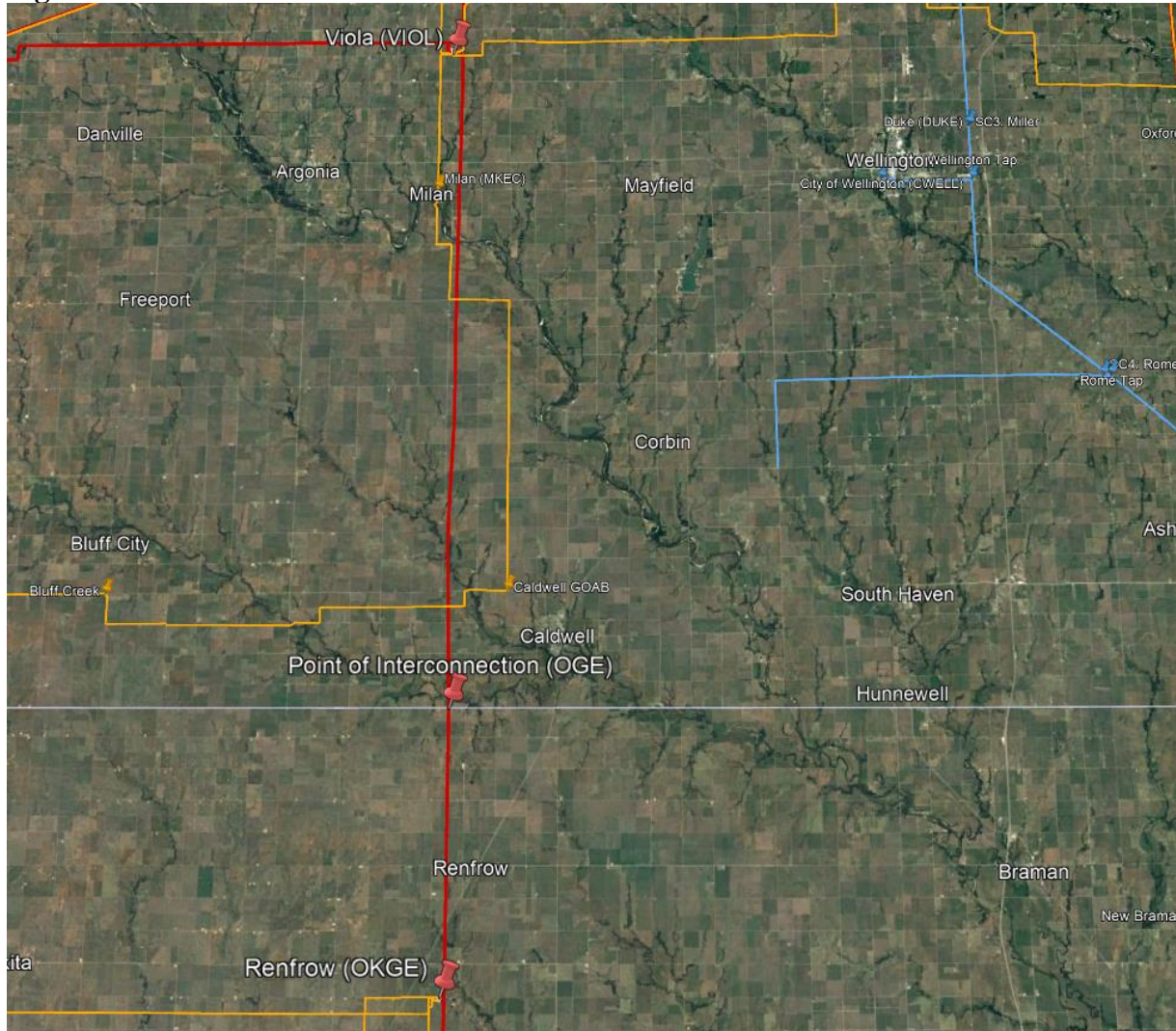



FACILITY STUDY

for

Generation Interconnection Request 2017-150

250 MW Solar Generating Facility
Grady County
Oklahoma

February 28, 2023

Benjamin Sasu
Senior Engineer
Transmission Planning
OG&E Electric Services

Summary

Pursuant to the tariff and at the request of the Southwest Power Pool (SPP), Oklahoma Gas and Electric (OG&E) performed the following Facility Study to satisfy the Facility Study Agreement executed by the requesting customer for SPP Generation Interconnection request Gen-2017-150. The request for interconnection was placed with SPP in accordance SPP's Open Access Transmission Tariff, which covers new generation interconnections on SPP's transmission system. The requirements for interconnection consist of adding a breaker and a new line terminal for a new Solar Farm at Minco 345kV to be this GIA request as well as Gen-2017-233. Since these two requests will share the same Gen-tie line and are a part of the same DISIS study group, costs for the total project will be divided equally among the two projects. If one GIA request is withdrawn or delayed for whatever reason, the GIA request that moves forward will be assumed to cover the remaining costs of the project. The total cost for OKGE to add a breaker, and a new line terminal for a new Solar Farm at Minco 345kV substation, the interconnection facility, is estimated at \$3,382,103.

Table of Contents

Table of Contents	3
Introduction	4
Interconnection Facilities	5
Interconnection Costs	6
One-Line diagram of Interconnection	7

Introduction

The Southwest Power Pool has requested a Facility Study for the purpose of interconnecting a Solar generating facility within the service territory of OG&E Electric Services (OKGE) in Grady County Oklahoma. The proposed 345kV point of interconnection is at Minco Substation in Grady County. This substation is owned by OKGE. The cost for adding a new 345kV terminal to Minco Substation, the required interconnection facility, is estimated at \$1,591,654.

Network Constraints in the Southwest Public Service (SPS), OKGE and Western Farmers Electric Cooperative (WFEC) systems may be verified with a transmission service request and associated studies.

Other Network Constraints in the American Electric Power West (AEPW), Southwest Public Service (SPS), OKGE and Western Farmers Electric Cooperative (WFEC) systems may be verified with a transmission service request and associated studies.

Interconnection Facilities

The primary objective of this study is to identify attachment facilities. The requirements for interconnection consist of adding a new 345kV terminal at Minco substation. This 345kV addition shall be constructed and maintained by OKGE. It is assumed that obtaining all necessary right-of-way for the line into Minco substation will be performed by the interconnection customer.

The total cost for OKGE to add a new 345kV terminal to Minco Substation, the interconnection facility, is estimated at \$3,382,103. This cost does not include building the 345kV line from the Customer substation into Minco Substation. The Customer is responsible for this 345kV line up to the point of interconnection. This cost does not include the Customer's 345-34.5kV substation and the cost estimate should be determined by the Customer.

This Facility Study does not guarantee the availability of transmission service necessary to deliver the additional generation to any specific point inside or outside the Southwest Power Pool (SPP) transmission system. The transmission network facilities may not be adequate to deliver the additional generation output to the transmission system. If the customer requests firm transmission service under the SPP Open Access Transmission Tariff at a future date, Network Upgrades or other new construction may be required to provide the service requested under the SPP OATT.

The costs of interconnecting the facility to the OKGE transmission system are listed in Table 1.

Short Circuit Fault Duty Evaluation

It is standard practice for OG&E to recommend replacing a circuit breaker when the current through the breaker for a fault exceeds 100% of its interrupting rating with re-closer de-rating applied, as determined by the ANSI/IEEE C37.5-1979, C37.010-1979 & C37.04-1979 breaker rating methods.

For this generator interconnection, no breakers were found to exceed their interrupting capability after the addition of the Customer’s 250MW generation and related facilities. OG&E found no breakers that exceeded their interrupting capabilities on their system. Therefore, there is no short circuit upgrade costs associated with the Gen-2017-150 interconnection.

Table 1: Required Interconnection Network Upgrade Facilities

Facility	ESTIMATED COST (2023 DOLLARS) Shared Costs Gen-2017-233 and Gen-2017-150	PERCENTAGE RESPONSIBLE
Lead Time	20 Months	
OKGE – Interconnection Facilities - Add one 345kV line terminals to Minco Substation. one dead end structures, line switch, line relaying, revenue metering including CTs and PTs	\$1,591,654	50%
OKGE – Network Upgrades at Minco sub, install One-345kV 3000A breaker, line relaying, disconnect switches, and associated equipment.	\$1,790,448	50%
OKGE - Right-of-Way for 345kV terminal addition	No Additional ROW	
Total Cost for Gen-2017-150	\$1,691,051	

Prepared by Benjamin Sasu
Senior Engineer, Transmission Planning
OG&E Electric Services

February 28, 2023

Reviewed by:
Adam Snap, P.E.
Manager, Transmission Planning
snappad@oge.com

MINCO Substation

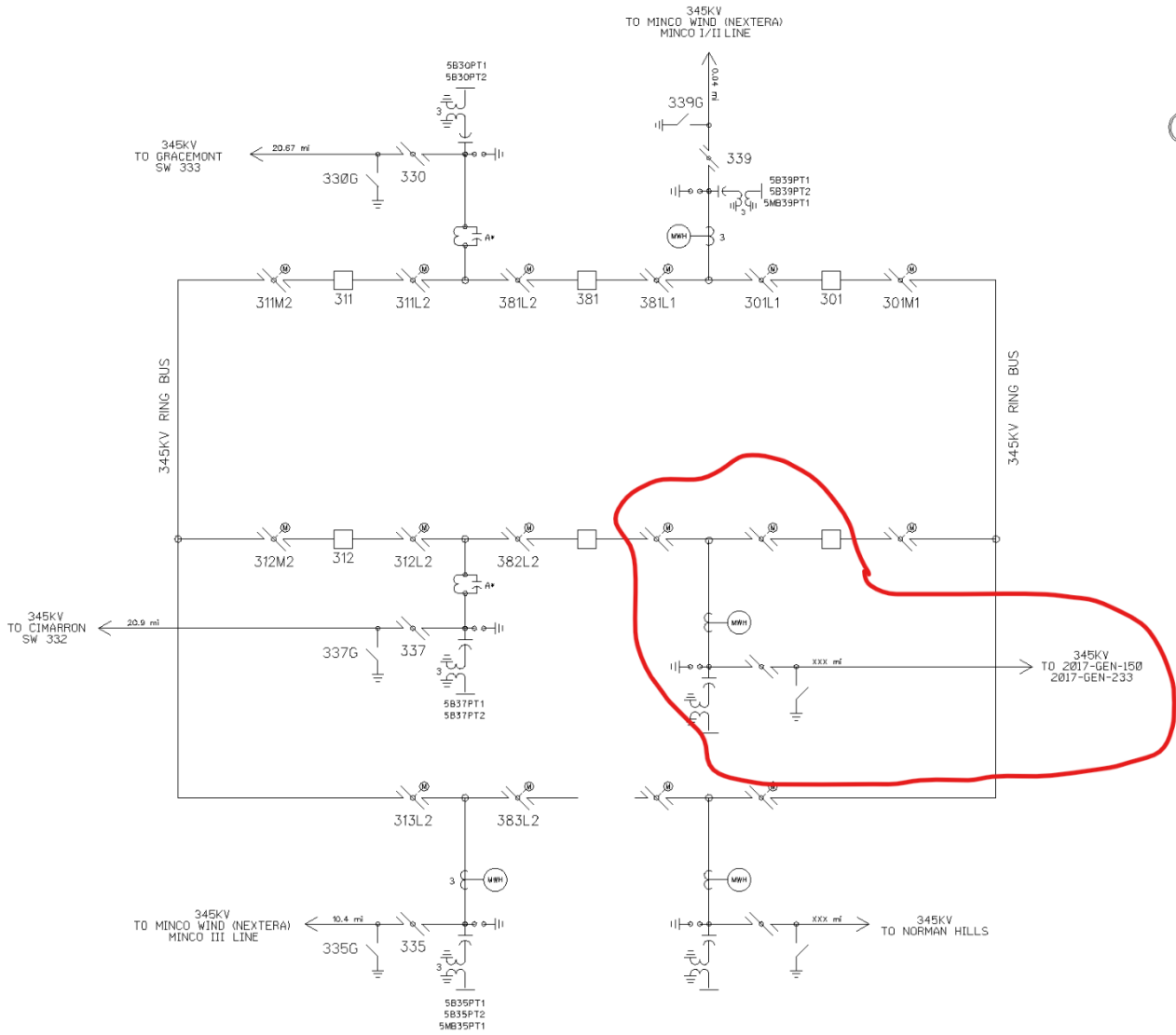



FACILITY STUDY

for

IFS-2017-002-156496 Network Upgrades For DISIS-2017-002

Switch Out Border Line Reactor
In Beckham County
Oklahoma

March 21, 2023

Chris Rich, P.E.
Transmission Planning Engineer
OG&E Electric Services

Summary

Pursuant to the tariff and at the request of the Southwest Power Pool (SPP), Oklahoma Gas and Electric (OG&E) performed the following Facility Study for Network Upgrades to satisfy the Facility Study Agreement executed by the requesting customer for SPP IFS-2017-002-1 for Network Upgrades. The request for interconnection was placed with SPP in accordance SPP's Open Access Transmission Tariff, which covers new generation interconnections on SPP's transmission system. The requirements for the Network Upgrade are to install one 345kV Reactor breaker/switch, and associated relay and control equipment in Border substation. The total cost for OKGE to complete these upgrades is \$1,790,448.

Table of Contents

Table of Contents	3
Introduction	4
Interconnection Facilities	5
Interconnection Costs	6
One-Line diagram of Interconnection	7

Introduction

The Southwest Power Pool has requested a Facility Study for Network Upgrades within the service territory of OG&E Electric Services (OKGE) in Beckham County Oklahoma. The proposed Network Upgrade Facilities are for the addition of a 345kV breaker for the existing 50 Mvar reactor at Border substation in Beckham County, Oklahoma to allow for remote switching.

Network Constraints in the Southwest Public Service (SPS), OKGE and Western Farmers Electric Cooperative (WFEC) systems may be verified with a transmission service request and associated studies.

Other Network Constraints in the American Electric Power West (AEPW), Southwest Public Service (SPS), OKGE and Western Farmers Electric Cooperative (WFEC) systems may be verified with a transmission service request and associated studies.

Network Upgrade Facilities

The primary objective of this study is to identify network upgrades. The requirements for this Network Upgrade consist of installing a 345kV breaker for the existing 50 Mvar reactor at Border substation on the OG&E transmission system to allow for remote switching and to accommodate generator interconnection requests identified in SPP-GI DISIS-2016-002-1. These 345kV network upgrades shall be constructed and maintained by OKGE.

The total cost for OKGE to install one 345kV reactor breaker, and associated relay and control equipment to allow an existing 50 Mvar Reactor in Border substation to be remotely switched is estimated at \$1,790,448.

This Facility Study does not guarantee the availability of transmission service necessary to deliver the additional generation to any specific point inside or outside the Southwest Power Pool (SPP) transmission system. The transmission network facilities may not be adequate to deliver the additional generation output to the transmission system. If the customer requests firm transmission service under the SPP Open Access Transmission Tariff at a future date, Network Upgrades or other new construction may be required to provide the service requested under the SPP OATT.

The costs of interconnecting the facility to the OKGE transmission system are listed in Table 1.

Short Circuit Fault Duty Evaluation

It is standard practice for OG&E to recommend replacing a circuit breaker when the current through the breaker for a fault exceeds 100% of its interrupting rating with re-closer de-rating applied, as determined by the ANSI/IEEE C37.5-1979, C37.010-1979 & C37.04-1979 breaker rating methods.

For this Network Upgrade, no breakers were found to exceed their interrupting capability after the addition of the one breaker and related facilities. OG&E found no breakers that exceeded their interrupting capabilities on their system. Therefore, there is no short circuit upgrade costs associated with this DISIS-2017-002 Network Upgrade.

Table 1: Required Interconnection Network Upgrade Facilities

Facility	ESTIMATED COST (2023 DOLLARS)
Lead time	20 months
OKGE – Network Upgrades at Border Sub. Install 1-345kV Reactor Breaker/switch and associated relay and control equipment.	\$1,790,448
Total	\$1,790,448

Prepared by:
Chris Rich, PE
Staff Engineer, Transmission Planning
richcs@oge.com

March 21, 2023

Reviewed by:
Adam Snapp, P.E.
Manager - Transmission Planning
snappad@oge.com

March 27, 2023

Border Substation

